

OPERATION MANUAL

Manual No. CM400A

**DRUMTRAKS
OPERATION MANUAL**

by Stanley Jungleib

Sequential Circuits, Inc.
3051 North First Street
San Jose, CA 95134-2093
U.S.A.
408/946-5240
TELEX: 364412 INTR 706

DRUMTRAKS

Model 400

OPERATION MANUAL

by Stanley Jungleib

Art Assistance: Jay Oglevee

Manual No. CM400A

Issued: November, 1983

©1983 by

SEQUENTIAL CIRCUITS, INC.

All rights reserved. Printed in Japan.

Sequential Circuits, Inc.

3051 North First Street
San Jose, CA 95134-2093

U.S.A.

408/946-5240

TELEX: 364412 INTR 706

Sequential Circuits, Inc.

Nijverheidsweg 11c
3641 RP Mijdrecht

Netherlands

02979-6211

TELEX: 12721 SQNTL NL

Table of Contents

	<u>paragraph</u>	<u>page</u>
	About the Model 400 and this Manual	v
1	BASIC SETUP	
	1-1 Connections and Power On	1-1
	1-2 Master Volume	1-1
	1-3 Instrument Volume	1-3
	1-4 Accent	1-3
	1-5 Instrument Tuning	1-3
2	PLAYING PATTERNS	
	2-1 Pattern Run and Stop	2-1
	2-2 Selecting Patterns	2-2
	2-3 Cueing Patterns	2-2
	2-4 Playback Tempo	2-2
	2-5 Swing Value	2-3
	2-6 RUN/STOP Footswitch	2-3
	2-7 NEXT/REPEAT Footswitch	2-3
3	OVERDUBBING PATTERNS	3-1
4	RECORDING PATTERNS	
	4-1 Erase Pattern	4-1
	4-2 Basic Recording	4-2
	4-3 Time Signature	4-3
	4-4 # of Measures	4-4
	4-5 Instrument Volume	4-5
	4-6 Instrument Tuning	4-5
	4-7 Error Correct/Erase Instrument	4-6
	4-8 Overdub with Programmed Volume or Tuning	4-8
	4-9 Copying a Pattern	4-9
	4-10 Appending	4-9
	4-11 Memory Management	4-10
5	BUILDING BASIC SONGS	
	5-1 Erase Song	5-1
	5-2 Build Song	5-2
6	PLAYING SONGS	
	6-1 Run/Stop	6-1
	6-2 Selecting Songs	6-1
	6-3 Cue/Stop	6-2
	6-4 Tempo	6-2
	6-5 RUN/STOP Footswitch	6-2
	6-6 NEXT/REPEAT Footswitch	6-2

	<u>paragraph</u>	<u>page</u>
7	ADVANCED SONG FUNCTIONS	
	7-1 Copying a Song	7-1
	7-2 Appending Songs	7-1
	7-3 Editing Songs	7-2
	7-4 Inserting Steps	7-3
	7-5 Deleting Steps	7-4
	7-6 Extending a Song	7-5
	7-7 Volume Change	7-6
	7-8 Initial Tempo	7-8
	7-9 Relative Tempo Change	7-9
	7-10 Ending Songs and Exiting Build Mode	7-11
8	CASSETTE	
	8-1 Connection	8-1
	8-2 Save	8-2
	8-3 Verify	8-3
	8-4 Save Error	8-4
	8-5 Load	8-5
	8-6 Load Error	8-6
9	USING CHANNEL OUTPUTS	9-1
10	CLOCK IN/OUT	
	10-1 Clock In	10-1
	10-2 Clock Out	10-2
	10-3 Sequencer Interface	10-3
	10-4 Tape Sync Interface	10-4
11	USING MIDI	
	11-1 Connection	11-1
	11-2 External Instrument Control	11-1
	11-3 Using Two Drumtraks	11-2
	11-4 Use with Sequencer	11-3
12	DISPLAY SUMMARY	
13	HIDDEN FUNCTIONS	
14	DETAILS	
15	SPECIFICATIONS	
16	MIDI IMPLEMENTATION	

About the Model 400 Drumtraks and this Manual

In the tradition of SCI's fully-programmable performance synthesizers, the Model 400 Drumtraks simplifies the creation of highly complex and convincing rhythmic arrangements. The design strikes a remarkable balance between ease of use and depth of functions. In addition to enabling its thirteen digitally-stored percussion sounds to be recorded, overdubbed and edited with perfect timing, this flexible, multi-track rhythm sequencer easily programs the variations which keep things rhythmically interesting: individual instrument volume and tuning, "swing" balance, accents, and tempo changes. Yet the Drumtraks price is a fraction of the price of the equivalent real instruments and multi-track recorder.

Each instrument is playable with its own key: Bass, Snare, Rim, Tom 1, Tom 2, Crash Cymbal, Ride Cymbal, Closed Hi-Hat, Open Hi-Hat, Claps, Tambourine, Cowbell, Cabasa. The instruments have already been professionally-recorded for studio-quality sound and a character that records well on tape.

As a digital recording instrument, the Drumtraks can do things which are impossible with tape. Multi-tracking, mixing, editing, copying, and erasing can be done without re-recording, splicing, or accumulating noise and distortion through the processes of "mix-down" and "bouncing" parts between tape tracks. The Drumtraks contains a programmable mixer with a monophonic output (which can drive stereo headphones). For control by external mixers or processors, six audio channels (plus the metronome) are available at the back panel through standard 1/4-inch phone jacks (see Section 9).

The Drumtraks has two primary modes: pattern and song. Basically, songs are made by chaining patterns together. The memory capacity of 3289 notes can be allocated to up to 99 different patterns, any of which can be up to 100 measures long in any time signature. Tempo range is 40 - 250 beats-per-minute. Each overdub of a pattern can be recorded with a different instrument volume or tuning, in real time (exactly as played), or auto-corrected to one of eight levels of resolution. Any part of an instrumental track can be erased. Patterns can be copied and added together (appended).

Up to 99 songs can be defined, which can consist of up to 100 steps. Steps specify how the song is built by selecting patterns and inserting volume or tempo changes. Songs, too, can be edited, copied and appended.

The Drumtraks memory is retained even when power is off thanks to a backup battery with a ten-year life. For permanent storage and reprogramming, the built-in interface can be used to store the contents of memory on a common cassette.

All functional information is displayed on four eight-segment LEDs. For performance, two jacks for optional footswitches allow "hands-free" starting and stopping of songs, pattern or song selection, and pattern repetition.

There are two built-in interface systems. For older sequencers or rhythm units and sync-to-tape there is a selectable 24, 48 or 96 pulse-per-quarter note clock input, and a 24- or 48-pulse clock output. For operation with computer-controlled sequencers, the new MIDI interface is also included. This enables the Drumtraks to synchronize to SCI's new Model 610 Six-Trak multi-timbral synthesizer/sequencer, or any other MIDI-equipped instrument. (For example, the Drumtraks can be played with full velocity control from the keyboard of the Prophet-T8.)

The Drumtraks has several levels of operation, allowing you both to learn how to use it immediately and to later explore its many options. For example, to start recording your own two-measure patterns, you simply select a pattern number, select record mode, then press RUN. An internal metronome provides the basic beat. As the pattern repeats itself (or, "loops") you can overdub any of the percussion instruments.

After becoming familiar with basic operation, you can change the number of measures in the pattern, the time signature (to any value), accents, error correct and swing parameters.

This manual begins with basic setup (Section 1), followed by the simplest operation, pattern playback (Section 2). After showing how to play patterns, the manual covers how to record and edit your own patterns (Sections 3 and 4). You can then build (Section 5) and play (Section 6) songs using pre-programmed or custom patterns. Then try some of the more advanced song functions (Section 7).

To keep instructions as stream-lined as possible, most explanatory material has been organized under Details (Section 14). Refer also to the enclosed card which contains brief instructions and descriptions of all controls and indicators.

I BASIC SET-UP

I-1 Connections and Power On

WARNING! Do not connect power yet.
Switch off all other equipment in use.

Connect Drumtraks AUDIO OUT to monitor system with monophonic cable, or plug in stereo headphones directly (both sides will be driven with a monophonic signal).

Check that back-panel power switch is OFF.

Connect line cord to power source at correct line voltage.

Switch power on.

Normal indications are that 00 appears in the Right display, and PATTERN # will be on. The Left display is blank.

Switch monitor system power on.

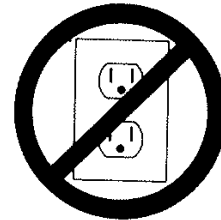

CONNECT DRUMTRAKS
(SEE NEXT PAGE)

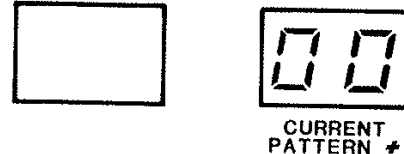

I-2 Master Volume

You can now "play" the Drumtraks by hitting any instrument key.

CAUTION: To protect speakers (and ears), first lower MASTER VOLUME all the way, then raise it to desired level while playing the instruments.

For best signal-to-noise ratio, raise MASTER VOLUME as far as possible (without causing distortion) while reducing the amplifier gain.



1 BASIC SET-UP

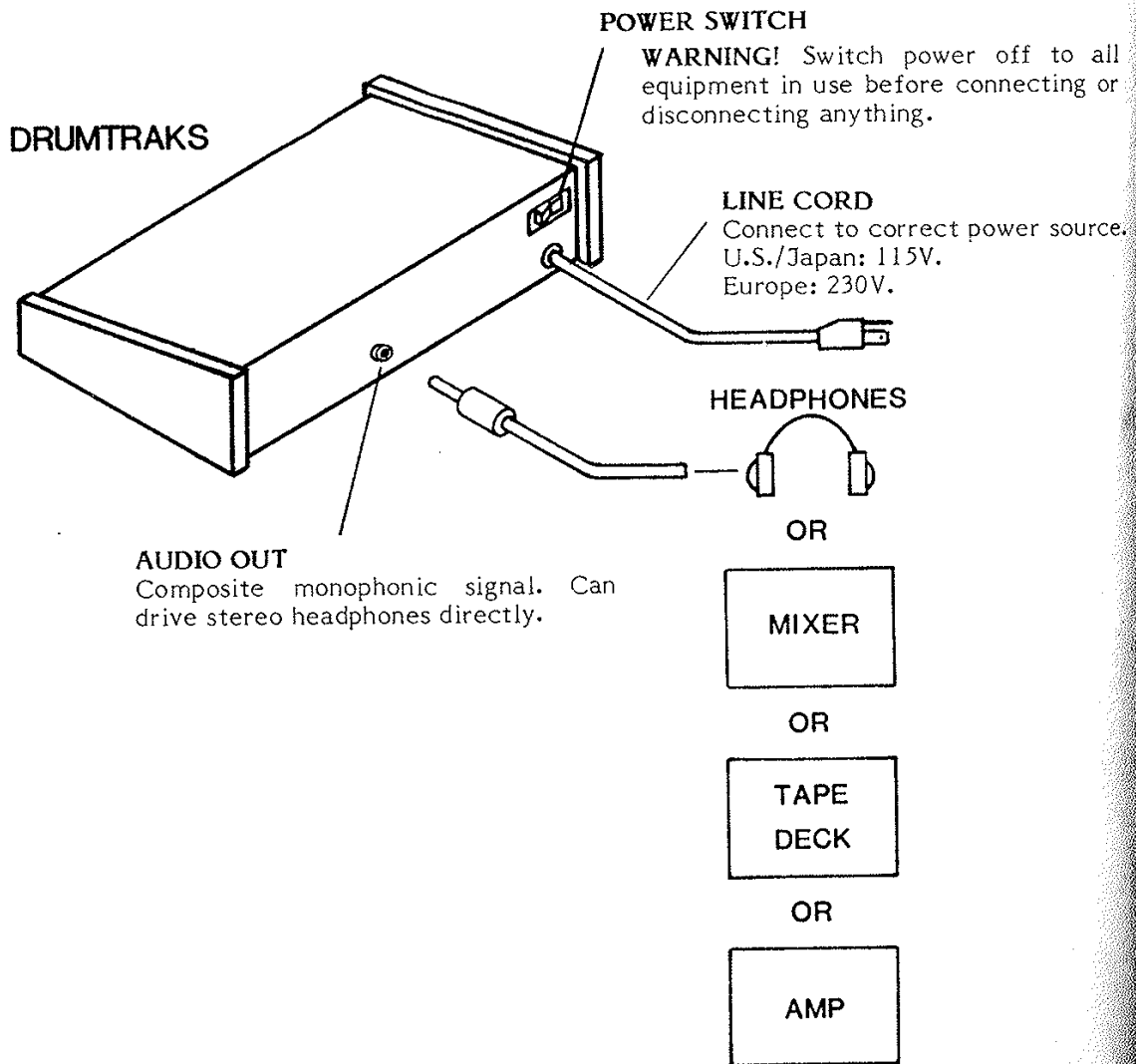

Figure 1-1
BASIC SET-UP

1 BASIC SET-UP

1-3 Instrument Volume

To change the volume of any instrument, adjust PER INSTRUMENT VOLUME as desired, while holding down the instrument key. The knob will adjust the volume to one of sixteen levels. While the key is held and the knob turned, the level number (00 - 15) will be displayed on the Left.

The resulting instrument mix will be retained through all patterns and songs until you specifically change it in this way (or until a song with programmed volume changes is run).

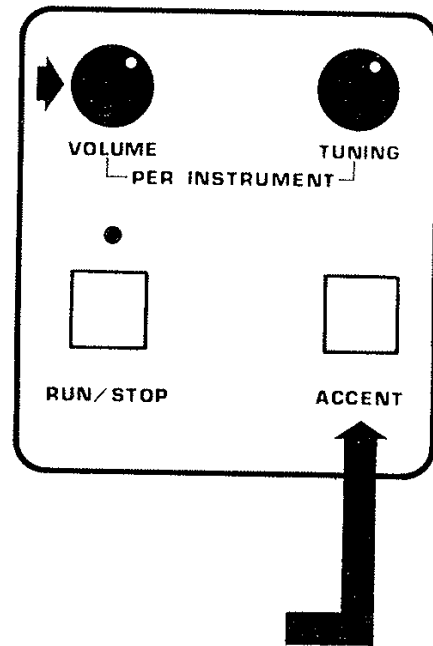

1-4 Accent

If ACCENT is held, playing any instrument key will accent that instrument.

1-5 Instrument Tuning

The tuning of any instrument can be adjusted in the same way as volume. Adjust PER INSTRUMENT TUNING as desired, while holding down instrument key. The knob will adjust the tuning to one of sixteen pitches. While the key is held and the knob turned, the pitch number (00 - 15) will be displayed on the Left.

As with volume, this instrument tuning will stay the same through all patterns and songs until you specifically change it.

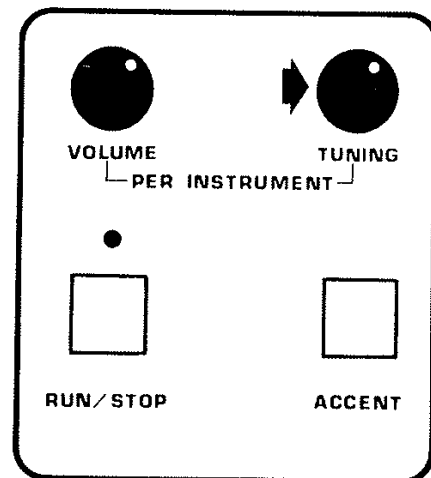

2 PLAYING PATTERNS

The Drumtraks comes pre-programmed with a few patterns (and songs), which can be played immediately by following these instructions. If you are operating a display unit keep in mind that someone may have altered or erased these "factory" patterns. To create your own patterns, see Section 4.

2-1 Pattern Run and Stop

To playback a pattern, PATTERN # must be on. If it is not on, use SELECT PATTERN FUNCTIONS.

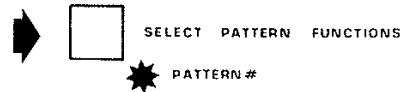

If power has just been turned on, pattern 00 is automatically selected. This (or the current pattern number) is indicated in Right display.

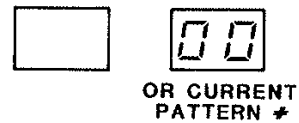

Press RUN.

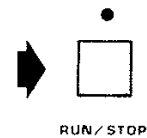

If selected pattern is empty, the RUN LED will go off immediately.

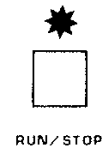

An existing pattern will start and repeat automatically ("loop"). RUN will light.

The front panel will blink on the first beat of each loop.

While the pattern is running you can play any of the instruments normally, without this playing being added to the programmed pattern.

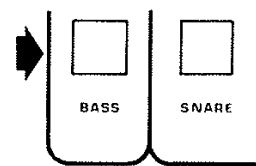

PER INSTRUMENT VOLUME and TUNING can be adjusted by pressing the desired instrument key.

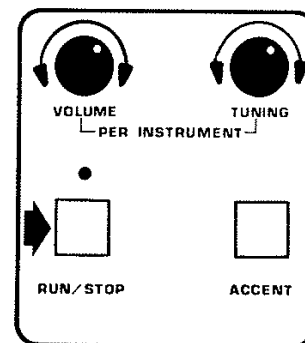

To stop pattern, press STOP.

If you press RUN again, the pattern will restart from its beginning (rather than from the point at which it was stopped).

2 PLAYING PATTERNS

2-2 Selecting Patterns

While stopped, select another pattern number by entering two digits (00-98). (99 is always empty.)

Or press Increment or Decrement (INC/DEC).

2-3 Cueing Patterns

To have one pattern stop and another start automatically, you can "cue" the next pattern:

While the current pattern is running, select the next pattern number. When the current pattern finishes its current loop, the new pattern which you selected will start, in perfect time.

If the new selection is pattern 99 (which is always empty) or any other empty pattern, the current pattern will stop at its end (rather than loop). This can be used to obtain endings precisely at the pattern end (rather than at whatever point STOP happens to be pressed.).

2-4 Playback Tempo

When power is first applied, Tempo is set to 100 beats-per-minute. Unless you adjust TEMPO, patterns will play at this speed.

To change speed, press TEMPO SLOWER or FASTER. The changing tempo value will be displayed following a "T."

To display current tempo without changing it, hold both TEMPO switches.

All patterns will play at the selected tempo until you change it (or play a song which has tempo changes).

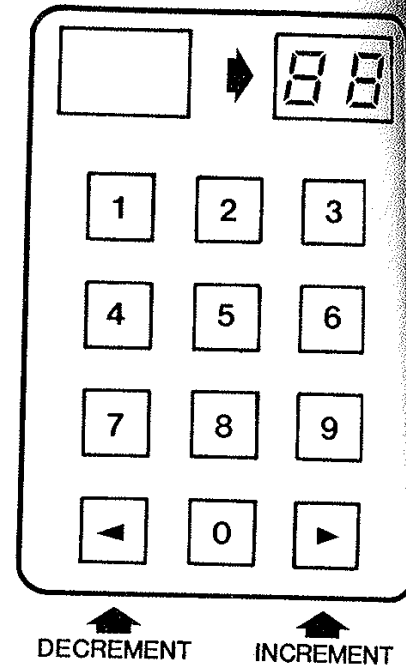

← PLEASE NOTE

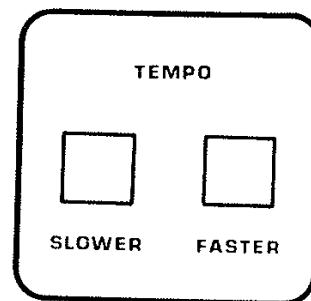

2 PLAYING PATTERNS

2-5 Swing Value

To adjust swing value of a pattern, the Drumtraks must be stopped.

Select SWING % with SELECT PATTERN FUNCTIONS switch. The swing value is shown in Right display. The value is set by default to 50, but may be changed to 54, 58, 62, 66, or 70% with INC/DEC.

The pattern will always play with the selected swing, until it is changed again.

If RUN is pressed, the function will automatically return to PATTERN # and the pattern will start.

Note that SWING % can only be changed when the time signature beat value (denominator) is 4. (For more information, see Details at the back.)

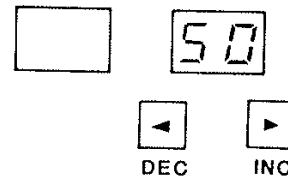
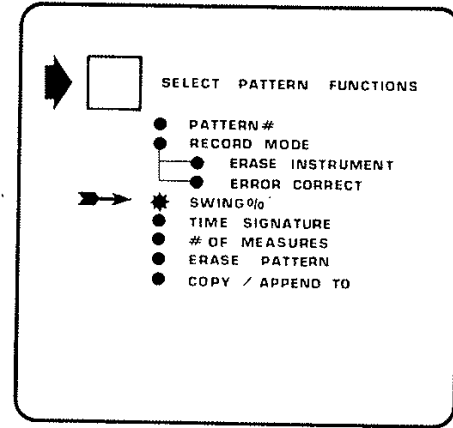

2-6 RUN/STOP Footswitch

If desired, connect optional footswitch to RUN/STOP FTSW jack.

This footswitch duplicates the function of the RUN/STOP switch. It can be used to start and stop playback. This makes it easier to obtain precise starting when the hands are busy elsewhere.

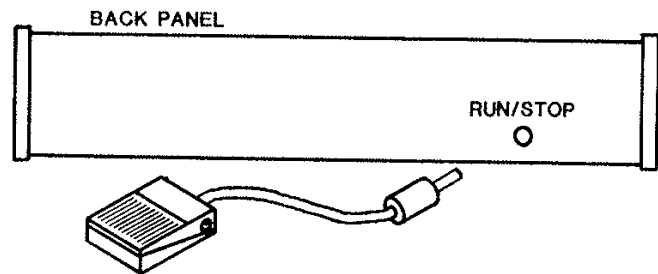

2-7 NEXT/REPEAT Footswitch

If desired, connect optional footswitch to NEXT/REPEAT FTSW jack.

Pressing this footswitch will select the next pattern number, for cueing or precise endings (by selecting an empty pattern). REPEAT is a song function. See page 6-2.

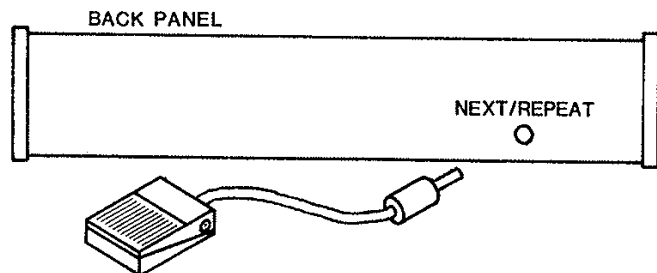

3 OVERDUBBING PATTERNS

The section covers basic overdubbing of existing patterns. For more pattern functions, see Section 4. Only patterns can be overdubbed, not songs. Overdubbing a pattern will affect all songs which contain that pattern.

Select PATTERN # (using SELECT PATTERN FUNCTIONS switch).

Select desired pattern.

If desired, RUN pattern and adjust TEMPO, PER INSTRUMENT VOLUME or TUNING. STOP.

Select RECORD MODE (using SELECT PATTERN FUNCTIONS switch).

Press RUN (or footswitch).

The selected pattern will play and the metronome will click on the beat of the time signature. (For example, in 4/4 time it clicks on every quarter note.) Adjust METRONOME VOLUME as desired. The metronome will be accented each time the pattern loops.

Anything you play on the instrument keys will be recorded as part of the pattern.

As the edited pattern loops, the front panel will blink and your overdubbing will be included.

Note: Playing will be error-corrected to the default value of 1/16-notes. To learn how to use Error Correct and Erase Instrument, see page 4-6.

To stop editing, press STOP (or footswitch).

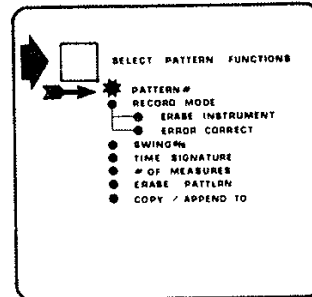

EXAMPLE

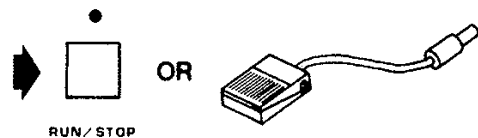
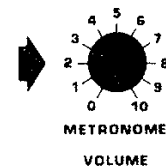
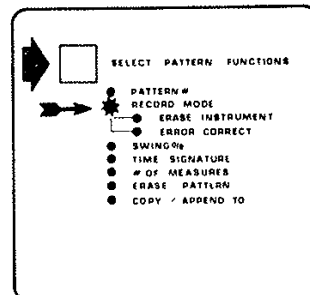
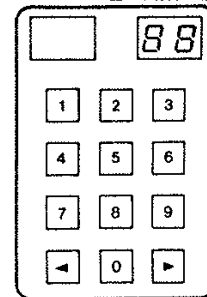

4 RECORDING PATTERNS

The Drumtraks can store 99 patterns, numbered 00-98. (Pattern 99 cannot be recorded. It is reserved for use as a "stop" function.)

This section first covers simple recording with the following "default" values for the pattern:

ERROR CORRECT 1/16
SWING 50%
TIME SIGNATURE: 4/4
OF MEASURES 1

It then discusses how to change these and other options.

Note: If it is desired to save the factory patterns using the cassette interface, do so now, before erasing or recording (see Section 8).

4-1 Erase Pattern

Before a pattern can be recorded under a number, the location must be cleared with the ERASE PATTERN function. This protective arrangement helps prevent you from accidentally recording over a desired pattern.

Use SELECT PATTERN FUNCTIONS switch to advance to ERASE PATTERN.

Enter two digits of pattern number to be cleared.

Note: Be sure to enter the right numbers or you may accidentally erase a valuable pattern. If you entered the wrong first digit, you can escape by pressing SELECT twice (before the second digit is entered).

When the second digit is entered the pattern will be cleared.

The function will automatically return to PATTERN #.

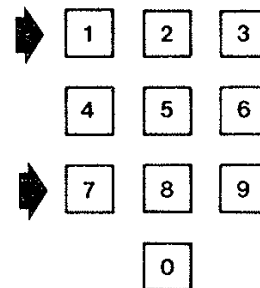
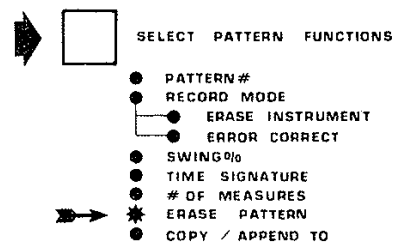

4 RECORDING PATTERNS

4-2 Basic Recording

Check that desired, empty PATTERN # is displayed. (Pattern 99 cannot be recorded.)



Select RECORD MODE.

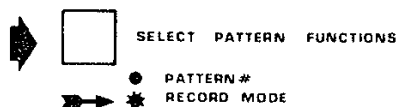

When you press RUN (or the footswitch), recording will start. The metronome will play on the beat specified by the time signature (for example, on each quarter note for 4/4). On the first beat of each loop the metronome is accented and the front panel blinks.

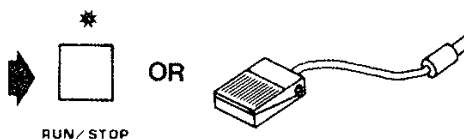

Adjust METRONOME VOLUME as desired.

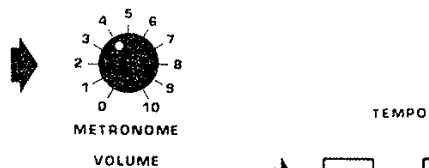

Adjust TEMPO as desired.

To play on the first beat, you can either play immediately after pressing RUN (or footswitch), or wait for the next loop.

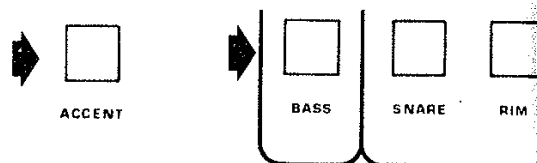

Any instrument parts can be recorded with or without accents.

When done recording, press STOP (or footswitch). The function will automatically return to PATTERN #.



To playback, press RUN.

4 RECORDING PATTERNS

4-3 Time Signature

Unless the default value of 4/4 is desired, TIME SIGNATURE must be set before recording. It can only be adjusted when the pattern is empty (erased as explained on page 4-1).

Select PATTERN #.

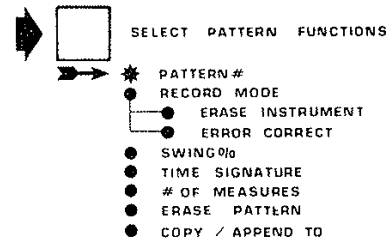

Select desired empty pattern number.



Select TIME SIGNATURE.

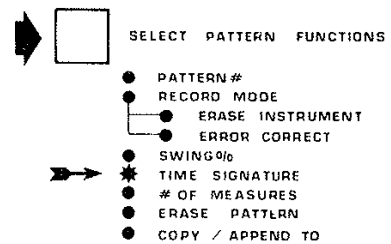

Enter two-digit number for numerator (beats-per-measure).

(The display will not accept more than two digits. If you make a mistake, continue.)

Use INC/DEC to select the denominator (beat value).

Select next function (usually # OF MEASURES or RECORD MODE).

(If you made a mistake entering the beats per measure, reselect TIME SIGNATURE function to enter correct number of beats per measure.)

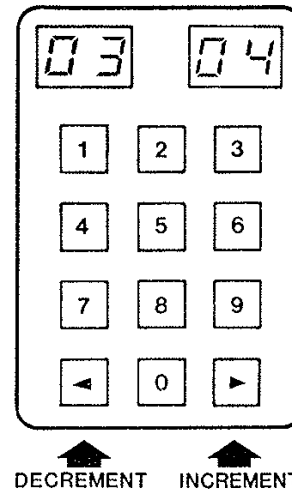

4 RECORDING PATTERNS

4-4 # of Measures

Unless the default value of one measure is desired, # OF MEASURES must be set before recording. It can only be adjusted when the pattern is empty (erased as explained above).

Select PATTERN #.

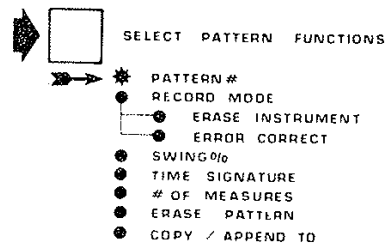

Select desired empty pattern number.

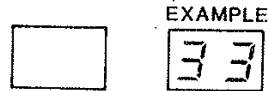

Select # OF MEASURES.

Enter two-digit number or use INC/DEC.

Select next function (usually PATTERN # or RECORD MODE).

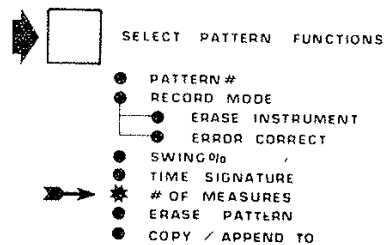

4 RECORDING PATTERNS

4-5 Instrument Volume

After defining the time signature and number of measures, you may want to program the instrument volumes so that whenever this pattern is played, it will always have the same mix.

If you do not program instrument volume, the pattern will always play with whatever basic mix happens to be set.

To program instrument volume:

Select PATTERN #.

Adjust PER INSTRUMENT VOLUMES as desired.

Select RECORD MODE.

Play each instrument once by running your finger down the row of instrument keys. Or, just hit the keys to be recorded at this time. This records the current volume setting of each instrument with the pattern.

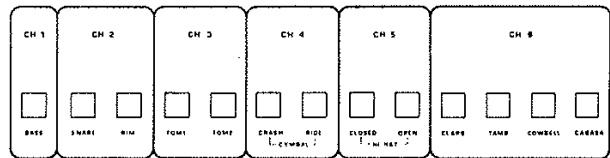
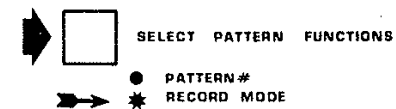
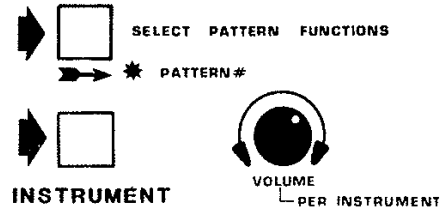

4-6 Instrument Tuning

You may also want to program instrument tuning so the pattern will always play with the same tunings. This can be done similarly to instrument volume.

If you do not program instrument tuning, the pattern will always play with whatever basic tuning happens to be set.

To program instrument tuning:

Select PATTERN #.

Adjust PER INSTRUMENT TUNINGS as desired.

Select RECORD MODE.

Play each instrument once by running your finger down the row of instrument keys. Or, just hit the keys to be recorded at this time. This records the current tuning of each instrument with the pattern.

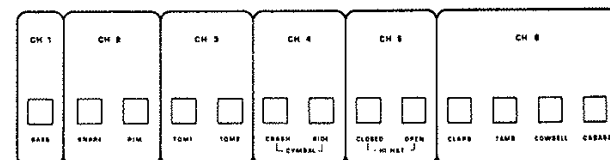
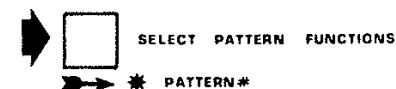

4 RECORDING PATTERNS

4-7 Error Correct/Erase Instrument

With the instrument volumes and tunings programmed (or not, as desired) you are now ready to start editing. This paragraph explains how the ERROR CORRECT and ERASE INSTRUMENT functions are typically used.

ERROR CORRECT is used to eliminate subtle timing errors from the pattern. The degree of error-correction is represented by a note value from 1/2 to 1/96, with 1/2 note being maximum correction and 1/96 being highest resolution. The general principle for error correction is to use the lowest resolution required to record the note in the desired place.

ERASE INSTRUMENT is used to remove playing errors from a pattern. In this mode, the instrument keys will not produce sound.

Notes always play error-corrected to the value which happens to be selected when the notes are recorded. If you wish to change their correction, erase the part, set ERROR-CORRECT as desired, then overdub the part back in, as explained below:

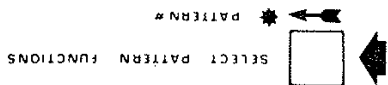

Select PATTERN #.

Select desired pattern #.



Select RECORD MODE.

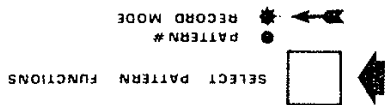

Press RUN. The metronome will start.

Press SELECT twice to light ERROR CORRECT. The current value will be displayed with "I-" on the Left and the note value, e.g. "16," on the Right.

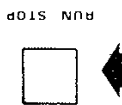

Assume, for example, that the BASS is to be played only on quarter-note beats. Use DEC to lower the ERROR CORRECT value from its 1/16 default to 1/4.

Now play the BASS near the quarter-note metronome beats, and observe on the next loop how it has been recorded in perfect time.

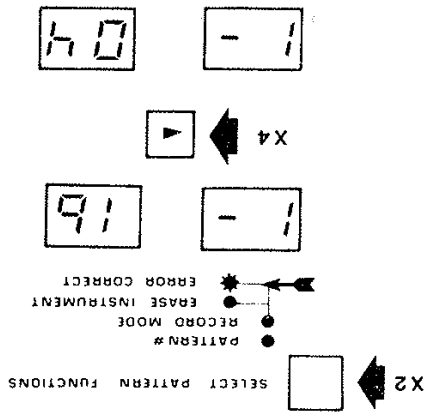

4 RECORDING PATTERNS

4-7 Error Correct/Erase Instrument cont'd

In preparation for recording a SNARE part, for example, you might raise ERROR CORRECT to 1/8. Play the SNARE.



SNARE

While the pattern loops, you might raise ERROR CORRECT to 1/16 and try some TOM rolls.



TOM1

This should give you the idea of how ERROR CORRECT is used.

If it seems that a part isn't recording right where you want it, press SELECT twice to activate ERASE INSTRUMENT. "Er" (for erase) will show in the Right display.

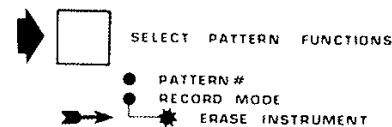

TOM1

With ERASE INSTRUMENT on, pressing any instrument key will clear notes recorded for that instrument, only while the key is held. Be sure to press the right key or you may clear the wrong instrument from the pattern.

If desired, an erased instrument can be overdubbed back in. Switch ERASE off by pressing SELECT once (which lights ERROR CORRECT).

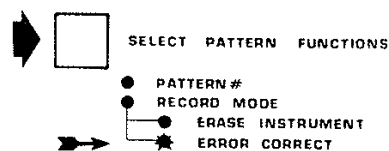

To stop editing, press STOP (or footswitch).



RUN/STOP

OR

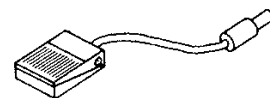

4 RECORDING PATTERNS

4-8 Overdub with Programmed Volume or Tuning

Suppose that you have a pattern complete with programmed volume and tuning. Over this pattern it is possible to overdub additional notes programmed with a different volume or tuning than are already in the pattern:

While the pattern plays, adjust volume and tuning of the instruments to be used in the overdub.



Stop the pattern.



Select RECORD MODE.

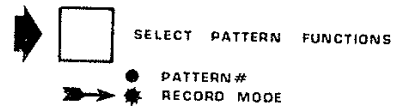

Hit the instrument keys to program them to the current volume and tuning settings.

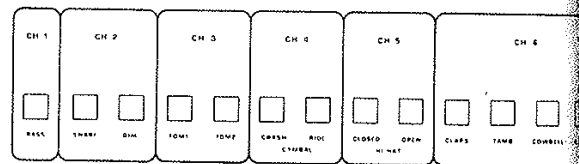

Run the pattern.



Overdub the instruments, which will record with their new volume and tuning values.

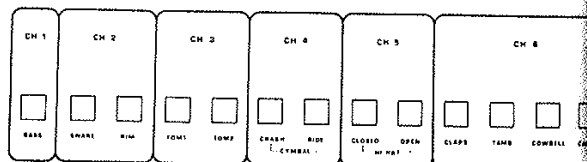

4 RECORDING PATTERNS

4-9 Copying a Pattern

To copy, first erase the destination pattern (see page 4-1).

Select the number of the pattern to be copied.

Select COPY/APPEND TO (Pattern).

Enter destination number digits. The pattern will be copied when the second digit is entered.

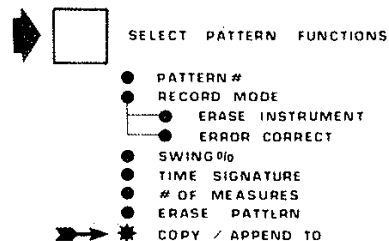

4-10 Appending

Select the number of the pattern you want to be at the end.

Select COPY/APPEND TO (Pattern).

Enter the number of the pattern to which you want the first pattern appended. The first pattern will be appended to the second pattern when the second digit is entered.

(To multiply its length, a pattern can be appended to itself.)

If the destination is empty, this is the same as COPY.

Note: More than one pattern can be appended. Also the patterns need not have the same time signature. For example, you can append a 7/8 pattern to one in 4/4. The total length of the new pattern would be four quarter notes plus seven eighth notes, although the displayed time signature will still be 4/4.

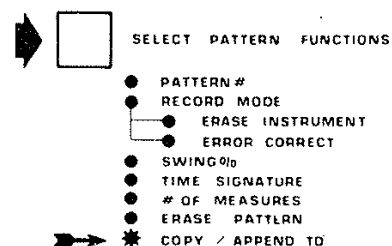
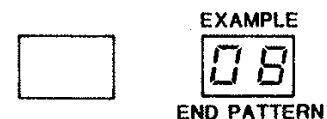

4 RECORDING PATTERNS

4-11 Memory Management

The Drumtracks has a maximum capacity of 3289 notes. However, every programmable accent, volume change, or tuning change takes additional memory, reducing the overall capacity.

Whenever the Drumtracks is stopped, the percentage of memory used can be read from the Left display by pressing both the INC and DEC switches.

When recording, if capacity is reached, the display will blink "FULL." If the METRONOME VOLUME is raised, a "beep" will also be heard. No further recording will be allowed.

To create more memory space, erase undesired patterns and songs.



% MEMORY
REMAINING



PATTERN #



5 BUILDING BASIC SONGS

The Drumtraks can store 99 songs, numbered 00-98. (Song 99 is always blank, for use as a "stop" function.) Basically, songs are chains of pattern selections. Each song can contain 100 steps. Steps are directions which tell the song to switch patterns, volumes, or tempo. This section covers simple pattern chaining. Other song functions are covered in Section 7.

Note: Whenever SONG # is on, the song number is always displayed on the left.

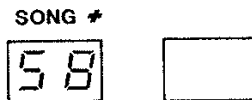

5-1 Erase Song

Before a song can be recorded under a number, the location must be cleared with the ERASE SONG function. This protective arrangement helps prevent you from accidentally recording over a desired song.

Advance to ERASE SONG, using SELECT SONG FUNCTIONS switch.

Enter two digits of song number to be cleared.

Note: Be sure to enter the right numbers or you may accidentally erase a valuable song. If you entered the wrong first digit, you can escape by pressing SELECT twice.

When the second digit is entered the song will be cleared.

The function will automatically return to SONG #.

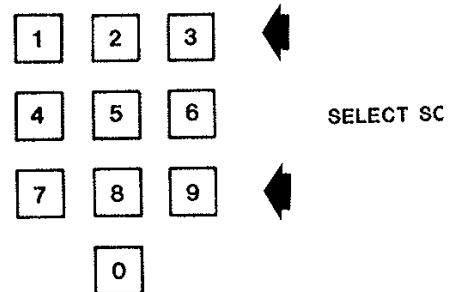
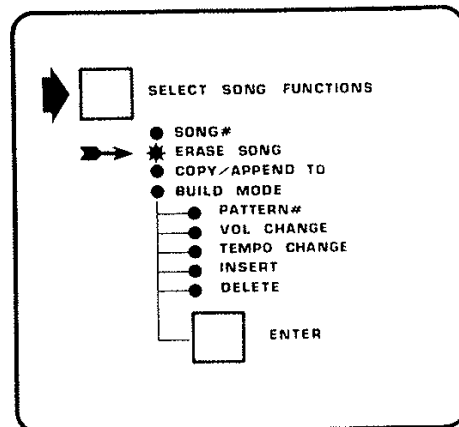

ERASED SONG

5 BUILDING BASIC SONGS

5-2 Build Song

There are five functions plus one ENTER switch associated with Build Mode.

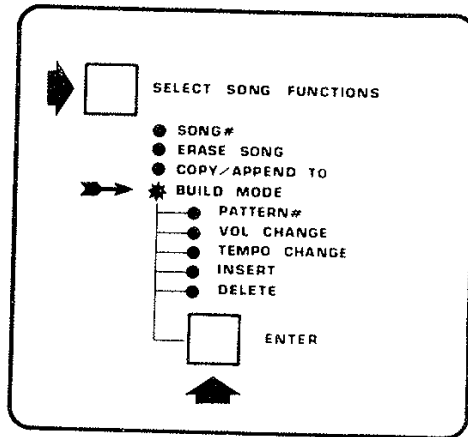

Whenever you wish to access Build Mode you must first select BUILD MODE by hitting the SELECT SONG FUNCTIONS switch until BUILD MODE lights. At this point you must press the ENTER switch located below BUILD MODE. You are now in Build Mode. By pressing the SELECT SONG FUNCTIONS switch you can cycle through the five functions available in Build Mode.

Suppose we want to build a simple song consisting of an AABA form. For example, in song 45 we want pattern 32 to play twice, switch to pattern 17, then replay 32. This song will contain five steps: four pattern selections plus an ending. The steps will be numbered 00-04.

(See example on next page.)

5 BUILDING BASIC SONGS

First, advance SELECT SONG FUNCTIONS to SONG #. Then:

	Song Function <u>LEDS</u>	Displays <u>Left</u>	<u>Right</u>
Enter two-digit song number, or use INC/DEC.	SONG #	45 (song)	blank
Select BUILD MODE	BUILD MODE	45	"
ENTER	BUILD MODE/ PATTERN #	00 (step)	E (current end)
32	"	00	32 (1st A pattern)
ENTER	"	01	E (current end)
32	"	01	32 (2nd A pattern)
ENTER	"	02	E
17	"	02	17 (B pattern)
ENTER	"	03	E
32	"	03	32 (last A)
ENTER	"	04	E
ENTER	SONG #	45 (song)	

(Function automatically returns to SONG #.)

Song 45 has now been built as follows:

<u>Step #</u>	<u>Entry (Pattern #)</u>
00	32
01	32
02	17
03	32
04	E (end command--press ENTER twice)

To view the steps that build song #45, enter BUILD MODE again.

At this point, PATTERN # (under BUILD MODE) should be lit.

Press the INC or DEC switches. These will change the step number as displayed on the left. On the right will be displayed the pattern number for each step.

6 PLAYING SONGS

6-1 Run/Stop

If no song functions are on, press SELECT SONG FUNCTIONS switch.

SONG # will be automatically selected and the Left display will indicate 00 (or the last song selected).

Enter desired song #.

Press RUN (or footswitch). The selected song will start. (If selected song is empty, or the first pattern in the song is empty, the RUN LED will go off immediately.)

While a song is running, the step number is displayed on the Left and the pattern number (or tempo or volume change) is displayed on the Right.

The front panel will blink on the first beat of each pattern.

If the final step of the song is an empty pattern (such as #99), the song will stop by itself.

Otherwise the song will loop until stopped by the footswitch (or an empty song number is selected—see "Cueing," next page.)

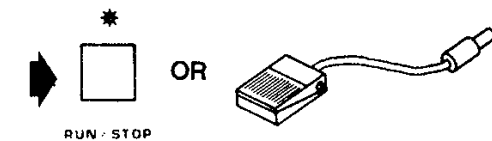

6-2 Selecting Songs

While stopped, select another song number by entering two digits, or using INC/DEC.

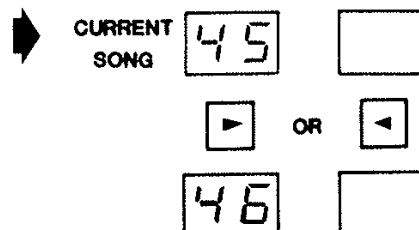

6 PLAYING SONGS

6-3 Cue/Stop

While running, select a different song number. It will be shown in the Left display.

When the current song finishes its current loop, the new song which you "cued-up" will automatically start.

Cueing can be used to make a song stop instead of loop: while the song plays, select #99 or another empty song number.

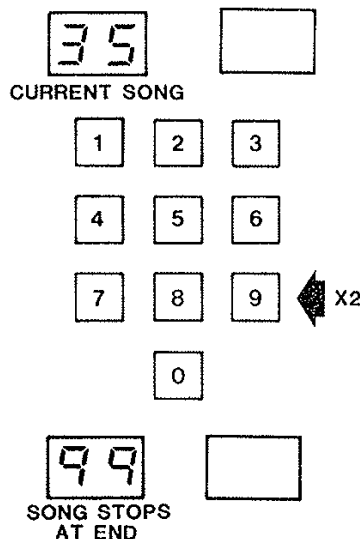

6-4 Tempo

A basic song will play at whatever tempo happens to be selected when it is run.

However, the initial starting tempo of the song can be programmed, as can "relative" tempo changes (see pages 7-8 and 7-9).

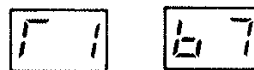
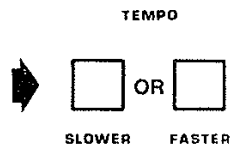

6-5 RUN/STOP Footswitch

In song mode, the RUN/STOP footswitch can control playback.

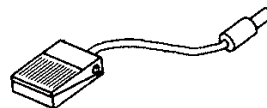

6-6 NEXT/REPEAT Footswitch

While running a song, if the REPEAT footswitch is held, the current pattern will repeat. When it is released, the song will continue normally.

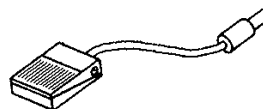

REPEATS SAME PATTERN IN SONG

7 ADVANCED SONG FUNCTIONS

7-1 Copying a Song



To copy, first erase the destination song (see page 5-1).

Select the number of the song to be copied.

 
EMPTY
DESTINATION

 
SONG TO
BE COPIED

Select COPY/APPEND TO (Song).

  SELECT SONG FUNCTIONS
● SONG#
● ERASE SONG
➔ ● COPY/APPEND TO

Enter destination number digits. The song will be copied when the second digit is entered.

 
COPIED SONG



(If initial tempo has been programmed in the song, it will be copied with the song.)

7-2 Appending Songs

Select the number of the song you want at the end.

 
ENDING SONG

Select COPY/APPEND TO (Song).

  SELECT SONG FUNCTIONS
● SONG#
● ERASE SONG
➔ ● COPY/APPEND TO

Enter the number of the song to which you want the first song appended. The first song will be appended to the second song when the second digit is entered.

 
BEGINNING
SONG

(If initial tempo has been programmed in the second song, it is ignored. However, relative tempo changes in the second song are still valid.)

Note: Songs can be appended to themselves.

7 ADVANCED SONG FUNCTIONS

7-3 Editing Songs

Let's suppose we have song 45 already given above (page 5-2) as an example:

<u>Step</u>	<u>Entry</u>
00	32
01	32
02	17
03	32
04	END

And we want to change it to an ABAB form, that is:

00	32
01	17
02	32
03	17
04	END

Advance SELECT to SONG #. Then:

EXAMPLE	Song Function <u>LEDS</u>	Displays	
		<u>Left</u>	<u>Right</u>
Select Song #	SONG #	00 (song)	
Press two-digit song number, or use INC/DEC.	SONG #	45 (song)	
Select BUILD MODE (If desired, program initial tempo--see paragraph 7-8.)	BUILD MODE	45	
ENTER	BUILD MODE/ PATTERN #	00 (step)	32 (current entry)
INC	"	01 (step)	32 (current entry)
17	"	01	17 (edited entry)
ENTER	"	02	17 (current entry)
32	"	02	32 (edited entry)
ENTER	"	03	32 (current entry)
17	"	03	17 (edited entry)
ENTER	"	04	E (current entry)

(To check the steps, you can use INC/DEC.)

To exit:

ENTER	SONG #	45 (song)
-------	--------	-----------

If only the first digit of a pattern number has been entered, pressing ENTER will leave the song unchanged and the function will return to SONG #.

7 ADVANCED SONG FUNCTIONS

7-4 Inserting Steps

Suppose you now have the following song, #45

<u>Step</u>	<u>Entry</u>
00	32
01	17
02	32
03	17
04	END

And you want to insert a short "fill" pattern, #66, in the middle to create an ABCAB form.

00	32
01	17
02	66
03	32
04	17
05	E

EXAMPLE

	<u>Song Function</u> <u>LEDS</u>	<u>Displays</u> <u>Left</u>	<u>Right</u>
Select Song #	SONG #	00 (song)	
Press two-digit song number, or use INC/DEC.	SONG #	45 (song)	
Select BUILD MODE	BUILD MODE	45	
ENTER	BUILD MODE/ PATTERN #	00 (step)	32 (current entry)
INC	"	01 (step)	17 (current entry)
INC	"	02	32
Select INSERT (using SELECT SONG FUNCTIONS)	BUILD MODE/ INSERT	02	32
Press ENTER (Inserts new step 2 and renumbers steps.)	BUILD MODE/ PATTERN #	02	(blank)
66		02	66
ENTER	"	03	32
ENTER	SONG #	45 (song)	

(If a step is inserted, but no value entered, the empty step will be ignored during playback.)

7 ADVANCED SONG FUNCTIONS

7-5 Deleting Steps

Suppose you now have the following song, #45

<u>Step</u>	<u>Entry</u>
00	32
01	17
02	66
03	32
04	17
05	E

And you want to take pattern #66 out.

00	32
01	17
02	32
03	17
04	END

EXAMPLE

	<u>Song Function LEDS</u>	<u>Displays</u>	
		<u>Left</u>	<u>Right</u>
Select Song #	SONG #	00 (song)	
Press two-digit song number, or use INC/DEC.	SONG #	45 (song)	
Select BUILD MODE	BUILD MODE	45	
ENTER	BUILD MODE/ PATTERN #	00 (step)	32 (current entry)
INC	"	01 (step)	17 (current entry)
INC	"	02	66
Select DELETE. (using SELECT SONG FUNCTIONS)	BUILD MODE/ DELETE	02	66
Press ENTER. (Deletes step.)	"BUILD MODE/ PATTERN #	02	32

7 ADVANCED SONG FUNCTIONS

7-6 Extending a Song

Suppose you have the following song, #45:

<u>Step</u>	<u>Entry</u>
00	32
01	17
02	32
03	17
04	END

And you want to add an ending to it, to produce:

00	32
01	17
02	32
03	17
04	24
05	END

EXAMPLE

	<u>Song Function</u> <u>LEDS</u>	<u>Displays</u>	
		<u>Left</u>	<u>Right</u>
Select Song #	SONG #	00 (song)	
Press two-digit song number, or use INC/DEC.	SONG #	45 (song)	
Select BUILD MODE	BUILD MODE	45	
ENTER	BUILD MODE/ PATTERN #	00 (step)	32 (current entry)
INC	"	01	17
INC	"	02	32
INC	"	03	17
INC	"	04	E
24	"	04	24
ENTER	"	05	E
ENTER	SONG#	45 (song)	

Note: If a song is extended with an empty pattern (such as pattern 99), the song will stop after one play, rather than loop.

7 ADVANCED SONG FUNCTIONS

7-7 Volume Change

As controlled by PER INSTRUMENT VOLUME, each instrument has sixteen volume levels. When a volume change is programmed into a song, all of the instrument volumes in the pattern following the change are decreased or increased by the number of volume steps in the change step.

For example, suppose you have the following song, #45:

<u>Step</u>	<u>Entry</u>
00	32
01	17
02	32
03	17
04	24
05	END

and you want all instrument volumes to drop by two levels for the second AB section. The song should then become:

00	32
01	17
02	U ₁ (The "U" actually signifies a "V" for volume change.)
03	32
04	17
05	24
06	END



which is done as follows:

(see example on next page)

7 ADVANCED SONG FUNCTIONS

7-7 Volume Change, cont'd

EXAMPLE	Song Function LEDS	Displays	
		Left	Right
Select Song #	SONG #	00 (song)	
Press two-digit song number, or use INC/DEC.	SONG #	45 (song)	
Select BUILD MODE	BUILD MODE	45	
ENTER	BUILD MODE/ PATTERN #	00 (step)	32 (current entry)
INC	"	01	17
INC	"	02	32
Select INSERT	BUILD/MODE/ INSERT	02	32
ENTER	BUILD MODE/ PATTERN #	02	(blank)
Select VOL CHANGE	BUILD MODE/ VOL CHANGE	U 7 	00
INC	"	U 7	01
DEC	"	U 7	00
DEC	"	U 7	01
DEC	"	U 7	02
ENTER	BUILD MODE/ PATTERN #	03	32
ENTER	SONG #	45 (song)	

Volume range for each instrument is limited to the values 0 through 15. In other words you can't add two 10-level volume changes to get a volume change of 20.

Volume changes are always effective. That is, if the song ends with an overall decrease in volume, each loop will get quieter. Conversely, each loop will get louder (to the maximum value of 15 for each instrument) if it has an overall increase. To defeat this feature, add a compensating volume change (in the opposite direction) at the end of the song.

7 ADVANCED SONG FUNCTIONS

7-7 Volume Change, cont'd

EXAMPLE	Song Function LEDS	Displays	
		Left	Right
Select Song #	SONG #	00 (song)	
Press two-digit song number, or use INC/DEC.	SONG #	45 (song)	
Select BUILD MODE	BUILD MODE	45	
ENTER	BUILD MODE/ PATTERN #	00 (step)	32 (current entry)
INC	"	01	17
INC	"	02	32
Select INSERT	BUILD/MODE/ INSERT	02	32
ENTER	BUILD MODE/ PATTERN #	02	(blank)
Select VOL CHANGE	BUILD MODE/ VOL CHANGE	U 7	00
INC	"	U 7	01
DEC	"	U 7	00
DEC	"	U 1	01
DEC	"	U 1	02
ENTER	BUILD MODE/ PATTERN #	03	32
ENTER	SONG #	45 (song)	

Volume range for each instrument is limited to the values 0 through 15. In other words you can't add two 10-level volume changes to get a volume change of 20.

Volume changes are always effective. That is, if the song ends with an overall decrease in volume, each loop will get quieter. Conversely, each loop will get louder (to the maximum value of 15 for each instrument) if it has an overall increase. To defeat this feature, add a compensating volume change (in the opposite direction) at the end of the song.

7 ADVANCED SONG FUNCTIONS

7-8 Initial Tempo

Pattern tempo is not programmable, but song tempo is. Songs will play at whatever TEMPO is set, unless you program the initial tempo as follows:

Select SONG #.

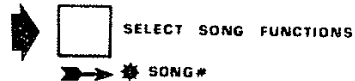

Select desired song.



Select BUILD MODE.

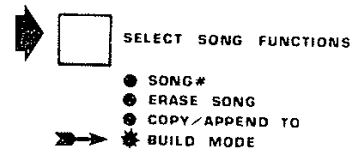

Press ENTER.



Select TEMPO CHANGE.

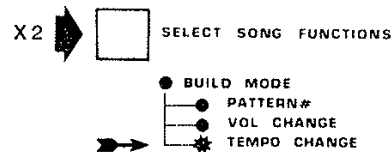

A TEMPO of 000 will be displayed. This signifies that there is no initial tempo.



TEMPO

Use SLOWER or FASTER to select desired initial tempo.

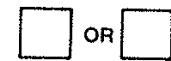

SLOWER FASTER

To clear initial tempo, press 0 on the keypad.



SELECTED INITIAL TEMPO

Press ENTER.



To exit BUILD MODE, press ENTER again.

Note: Song step 00 cannot be a tempo change.

7 ADVANCED SONG FUNCTIONS

7-9 Relative Tempo Change

Tempo changes which are relative to the starting tempo of the song can be programmed. The resulting tempo will be selected from the possible tempo values:

40	41	42	43	44	45	46	47	48	49
50	51	52	53	54	55	56	57	58	59
60	61	62	63	64	65	66	67	68	69
70	71	72	73	74	75	76	77	78	79
80	81	82	83	84		86	87		89
	91	92		94	95		97	98	
100		102	103		105		107		109
	111		113		115			118	
120		122			125			128	
130			133			136			139
			143			146			
150				154				158	
		162					167		
	171					176			
		182					187		
			193						
200							207		
				214					
		222							
	231								
240									
250									

TEMPO CHANGE steps are in the form, e.g., "up 9" or "down 12," meaning accelerating nine or decelerating twelve tempo values, respectively. For example if the song is at 105 bpm and is increased by nine tempo steps, the new tempo will be 125 bpm. Likewise, the step, down twelve, would change from 105 to 86 bpm. If the initial song tempo were changed to 94, the same tempo change steps would produce tempos of 109 and 78, respectively.

From song #45:

Step	Entry
00	32
01	17
02	U↓
03	32
04	17
05	24
06	END

To produce a four-level acceleration for the closing pattern:

00	32
01	17
02	U↓
03	32
04	17
05	T↖
06	24
07	END

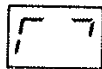

(see next page)

7 ADVANCED SONG FUNCTIONS

7-9 Relative Tempo Change, cont'd

EXAMPLE	Song Function LEDS	Displays	
		Left	Right
Select Song #	SONG #	00 (song)	
Press two-digit song number, or use INC/DEC.	SONG #	45 (song)	
Select BUILD MODE	BUILD MODE	45	
ENTER	BUILD MODE/ PATTERN #	00 (step)	32 (current entry)
INC	"	01	17
INC	"	02	-2
INC	"	03	32
INC	"	04	17
INC	"	05	24
Select INSERT	BUILD/MODE/ INSERT	05	24
ENTER	BUILD MODE/ PATTERN #	05	(blank)
Select TEMPO CHANGE	BUILD MODE/ TEMPO CHANGE	T ⁷	00
INC (x4)	"	T ⁷	04
ENTER	BUILD MODE/ PATTERN #	06	24
ENTER	SONG #	45 (song)	

Note also that since the maximum range of one tempo change step is +/- fifteen values, to achieve greater changes than this simply program two or more successive tempo change steps.

After the first loop, the song ignores its initial tempo. Tempo changes are always effective. That is, if the song ends with an overall decrease in tempo, each loop will get slower. Conversely, each loop will get faster (to the maximum value of 250 bpm) if it has an overall increase. To defeat this feature, add a compensating tempo change (in the opposite direction) at the end of the song.

7 ADVANCED SONG FUNCTIONS

7-10 Ending Songs and Exiting Build Mode

As you build or edit songs, the ending step is automatically inserted following the last pattern selection, tempo or volume change.

To exit build mode select (BUILD MODE) PATTERN #.

With no values pending, hit ENTER. (A value is pending when two digits have been entered for a pattern #.)

8 CASSETTE

8-1 Connection

Note: The instruments cannot be played during cassette operations.

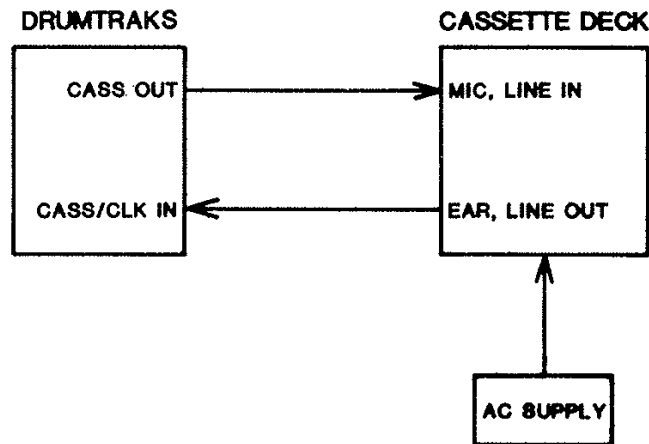

Figure 8-1
CASSETTE DECK CONNECTION

Connect a cassette recorder to the system.

CASS/CLK OUT goes to recorder input.

CASS/CLK IN comes from recorder output.

8 CASSETTE

8-2 Save

Note: Check that cassette deck is connected correctly.

To save memory on cassette:

Insert cassette into recorder and rewind to start of tape (or to tape counter position you are using).

Select SONG #, using SELECT SONG FUNCTIONS.

Put deck into record mode and wait a moment (for tape leader to pass and for the tape to stabilize.)

Press CASSETTE SAVE.

Use the pilot tone which appears, to adjust deck's record level to 0 dB, or slightly into the red.

When recording is done, CASSETTE LOAD will blink. This is a signal to begin verification.

The time required for saving varies according to the amount of memory actually used:

<u>Memory Remaining</u>	<u>Time Required</u>
99%	1/2 minute
50%	1-1/2 minutes
1%	2-1/2 minutes

(To display % Memory Remaining, hold both INC and DEC, and read Left display.)

◀◀ REWIND

SELECT SONG FUNCTIONS
* SONG#

▶ RECORD (TAPE)

CASSETTE



SAVE

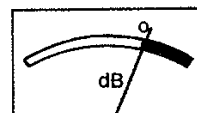

CASSETTE



(blinking)



LOAD

VERIFY

(SEE NEXT PAGE)

8 CASSETTE

8-3 Verify

Rewind to start of tape (or to tape counter position you are using).

Check playback level.

Put deck into play mode and wait a moment (for tape leader to pass and for the tape to stabilize.)

Press CASSETTE LOAD. The LED will stay lit during verification.

When verification is done, CASSETTE LOAD will go off. This signals the tape has been verified. You can remove it from the deck.

If instead of going off LOAD blinks, this means a tape save error has occurred.

As with saving, the time required for verify depends on the amount of memory actually used.

◀◀ REWIND

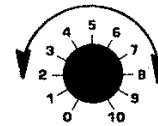

RECORDER
PLAYBACK VOLUME

▶ PLAY

CASSETTE



LOAD



OK

LOAD

★ (BLINKING)



LOAD

ERROR
(SEE NEXT PAGE)

8 CASSETTE

8-4 Save Error

Note: Ignore this paragraph unless a cassette fails to verify.

Check that deck is properly connected to CASS/CLK IN and OUT jacks.

Save errors are usually caused by incorrect record or playback levels with the deck. Rule-of-thumb for portable recorders is 75% of maximum output level. Optimum level can only be discovered by trial and error.

After readjusting playback level, try verification again.

If there is still an error, try adjusting the playback level in the other direction and try verification again.

If there is still an error, maybe it was the record level. Readjust and try re-recording.

If there is still an error, the tape itself could be bad, or the deck have excessive wow or flutter. Try a new cassette or another deck.

If trouble persists, contact your dealer, who will be able to isolate the problem.

**CHECK CABLES
(SEE PAGE 8-1)**



**VERIFY
(SEE PAGE 8-3)**



**VERIFY
RE-RECORD
(SEE PAGE 8-2)**

8 CASSETTE

8-5 Load

To load memory from cassette:

Insert cassette into recorder and rewind to start of tape (or to tape counter position you are using).

◀◀ REWIND

Select SONG #.

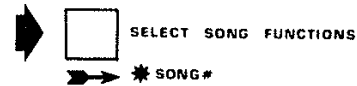

Put deck into play mode.

▶ PLAY

Check playback level.



Press CASSETTE LOAD. The LED will stay lit while loading.

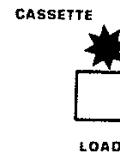

When loading is done, CASSETTE LOAD will go off. This signals the tape has correctly loaded. The Drumtraks is now reprogrammed.

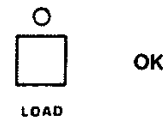

OK

If instead of going off, CASSETTE LOAD blinks, this means a load error has occurred.

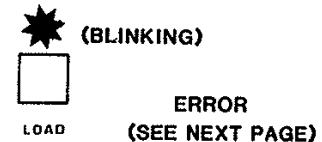

ERROR
(SEE NEXT PAGE)

As with saving and verify, loading time depends on the amount of memory loaded.

8 CASSETTE

8-6 Load Error

Note: Ignore this paragraph unless a cassette fails to load.

If the cassette was verified with the deck now in use, the load error can only be caused by the playback level or cable.

Check that the deck is properly connected to the CASS/CLK IN jack.

After readjusting playback level, try loading again.

If there is still an error, try adjusting the playback level in the other direction and try loading again.

If there is still an error, the tape itself could have been damaged, or the deck is too fast or slow, or has excessive wow or flutter. Try loading another cassette or using another deck.

If trouble persists, contact your dealer, who will be able to isolate the problem.

CHECK CABLES
(SEE PAGE 8-1)



LOAD
(SEE PREVIOUS PAGE)



9 USING CHANNEL OUTPUTS

If you have become familiar with the PER INSTRUMENT VOLUME control, you are aware that the Drumtraks has its own level-mixing facilities. But the internal mixer does not have pan facilities. In normal use all six audio channels plus the metronome are summed into a monophonic signal at the AUDIO OUT jack.

For maximum flexibility the output of each audio channel and the metronome are available through separate back-panel jacks. This allows you to create the desired stereo image with an external mixer. The mixer output can be used live or to drive a pair of tape tracks.

The channel outputs are still controlled by the PER INSTRUMENT VOLUME knob. For maximum signal-to-noise ratio, instrument volumes should be as high as possible. If using an external mixer you may want to set or program all instrument volumes to maximum level. The external mixer will also be handy to induce non-programmed increases and decreases in volume. Equalization can be used to slightly or radically alter the instrument tone. If available, effects devices such as chorus or delay can be inserted into any Drumtraks channel or applied to the mixer outputs. For example, the normal brief decay of most of the instruments can be synthetically lengthened with a regenerative delay line. Delay lines can also be used for synchro-sonic effects, in which precisely-timed echoes are rhythmically intermingled with the original material.

While recording, the metronome appears through AUDIO OUT, but not at the METRONOME OUT jack. During playback, the metronome does not appear through AUDIO OUT but does appear at METRONOME OUT. As the metronome is dc-coupled, it may actually be heard as a "double-click," which should not be used for a click track. (For an ac-coupled clock signal, see paragraph 10-2.) When multi-tracking, the metronome beat may be redundant or unnecessary when percussion is present (on other tracks), but may be extremely useful when the percussion is highly syncopated, is less dense, or is "sitting out" for a few measures.

The metronome signal is a very wide pulse that can be used to clock triggered sequencers (such as SCI's Pro-One, or the Prophet-600 Arpeggiator--which can be advanced through its footswitch jack). Since the metronome appears on the beat note of the time signature, in 4/4 the sequencer or arpeggiator could play quarter notes. But finer resolution can be obtained by adjusting the time signature and tempo. For example, to get an eighth-note clock you could use a time signature of 8/8 (or, for even higher resolution, 16/16 or 32/32.)

10 CLOCK IN/OUT

10-1 Clock In

While MIDI is preferred for syncing instruments, MIDI cannot interface to many earlier sequencers, nor can it be recorded on audio tape. Clock (CLK) sync from sequencer or tape is handy because it allows the Drumtraks to follow sequencer or tape speed changes.

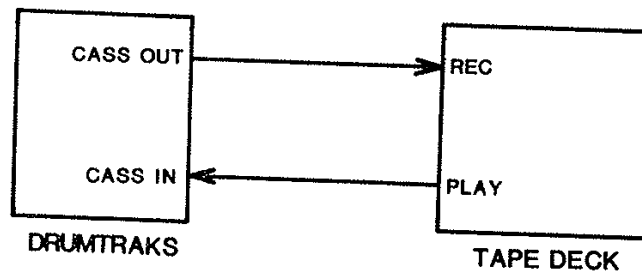

Figure 10-1
DRUMTRAKS/TAPE TRACK CLOCK CONNECTION

During playback the Drumtraks normally refers to its internal clock. This is the clock that is adjusted with the TEMPO switches. To switch the clock mode to synchronize playback to the pulses received at the CLK IN jack, follow the steps below. When the sequencer or tape track is played back, it will start the current pattern. Getting the pulses on to the tape track is discussed on the next page.

1. Hold both TEMPO switches.

2. Press ENTER.

3. The rightmost decimal point of the Right display will light to indicate external clock mode is set to 24 pulses per quarter note.

4. To change the external clock value, press DEC. The decimal point will move left once to indicate 48 pulses.

5. Press DEC again to select 96 pulses. The Left decimal point will light. (To select MIDI clock, press DEC once more.)

6. To switch back to internal clock mode, repeat steps 1 and 2. (The decimal point will go off.)

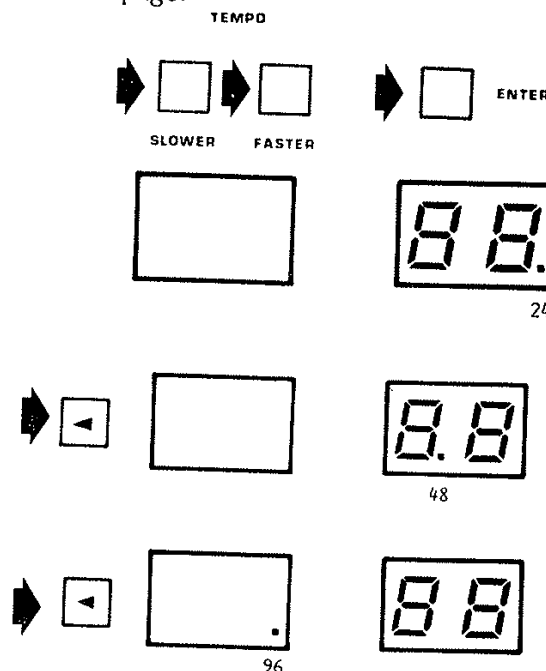

Note: During record, any external clock is always ignored.

10 CLOCK IN/OUT

10-2 Clock Out

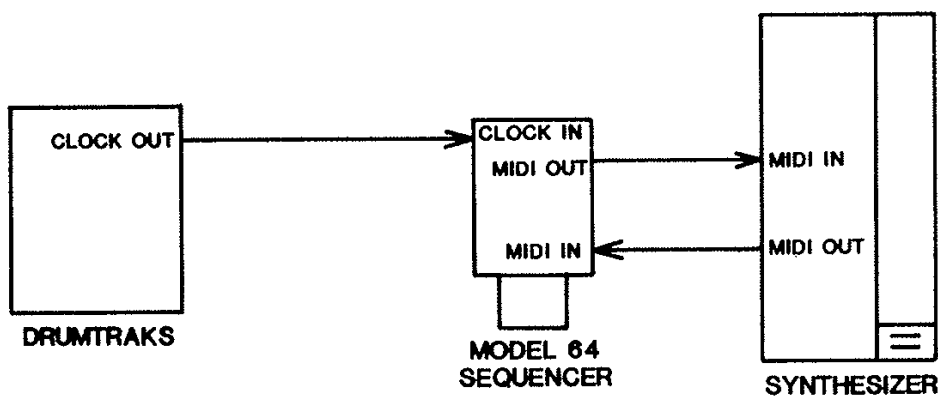

Figure 10-2
DRUMTRAKS/SEQUENCER CLOCK CONNECTION

In the system shown above, the Drumtraks clock synchronizes the synthesizer through the Model 64 sequencer. Only during Drumtraks playback, a 24- or 48-PPQN sync clock appears at the CASSETTE and CLOCK OUT jacks. This synchronization signal can be sent to sequencers or synthesizers which contain sequencers, or to a tape track.

To select a 48 PPQN clock output, hold ENTER and press "2." This signal will be a 20 usec pulse.

ENTER
 (HOLD IT)

2 48 PPQN OUT

To switch back to 24 PPQN square wave, hold ENTER and press "1."

ENTER
 (HOLD IT)

1 24 PPQN OUT

10 CLOCK IN/OUT

10-3 Sequencer Interface

Typically you might use the Drumtraks clock out with a sequencer as follows:

First create the percussion song on the Drumtraks.

The clock out rate will be 24 PPQN unless you change it.

Check that the CLOCK OUT is correctly cabled correctly to the sequencer clock input.

(The signals from CASSETTE and CLOCK OUT differ only in their drive characteristics. CLOCK OUT is dc-coupled--so preferred for interfacing sequencers, while CASSETTE OUT is ac-coupled, thus preferred for sync-to-tape (but can be used to clock some high-impedance sequencer inputs).

Check that the sequencer clock input rate is switched to match the Drumtraks (usually 24 PPQN).

Put the sequencer into record mode, but don't start it.

Start the Drumtraks with the footswitch. CLOCK OUT will start. The sequencer will start recording.

Play accompaniment on the synthesizer.

After drum part ends, switch off sequencer recording with sequencer footswitch.

Put sequencer in play mode (and again, don't start it).

Restart Drumtraks song with footswitch.

Sequencer will playback in sync. If desired, adjust tempo.

10 CLOCK IN/OUT

10-4 Tape Sync Interface

It is of course possible to record the Drumtraks monophonic or channel outputs on to one or more tape tracks. However this is not really necessary. Drumtraks playback can be synchronized to the tape program by using only one track. Not recording the drum part on tape leaves you the flexibility to edit the drum part while it is still in the Drumtraks itself. But also, if it becomes necessary to vary the tape playback speed, this will not affect the tuning of the percussion parts.

Basic guidelines for using the Drumtraks with a multi-track tape recorder are:

First create the percussion song on the Drumtraks.

Check that CASSETTE OUT is correctly cabled to the one tape track input.

Check that CASSETTE/CLK in is driven by the tape track output.

The clock out rate will be 24 PPQN unless you change it.

Check that the input clock rate is switched to match.

Set up other tape track(s) to record instruments.

Put the recorder into record mode. Check that the sync track monitor signal is turned all the way down.

Start the Drumtraks with the footswitch. CLOCK OUT will start.

Perform instrumental track(s).

After drum part ends, switch off tape record mode and rewind.

Turn up sync track playback. Play tape tracks. Drumtraks will play in sync when it receives the clock.

If desired, adjust tape speed. Drumtraks will remain in sync.
When editing is complete, record the Drumtraks output on a track.

If desired, the sync track could then be used to playback a second Drumtraks song.

11 USING MIDI

Note: This section covers MIDI operation. For MIDI programming information see Section 16, MIDI IMPLEMENTATION.

11-1 Connection

Connect MIDI cable from MIDI IN to sequencer or synthesizer's MIDI OUT.

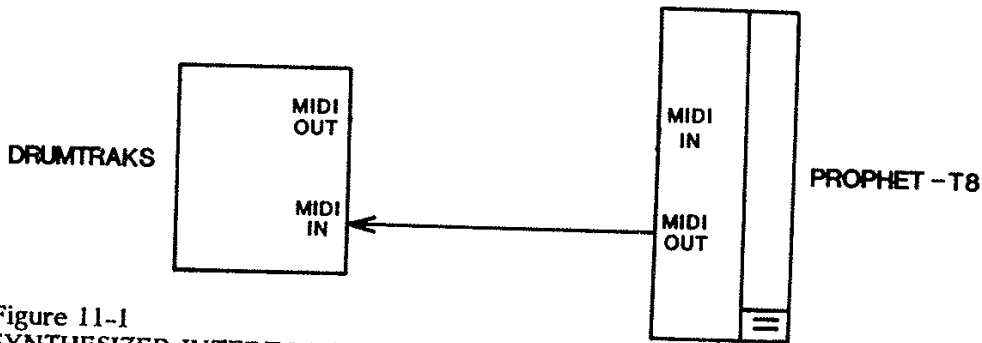

Figure 11-1
SYNTHESIZER INTERFACE

11-2 External Instrument Control

When power is switched on, an external (synthesizer) keyboard will key the Drumtraks instruments, as follows:

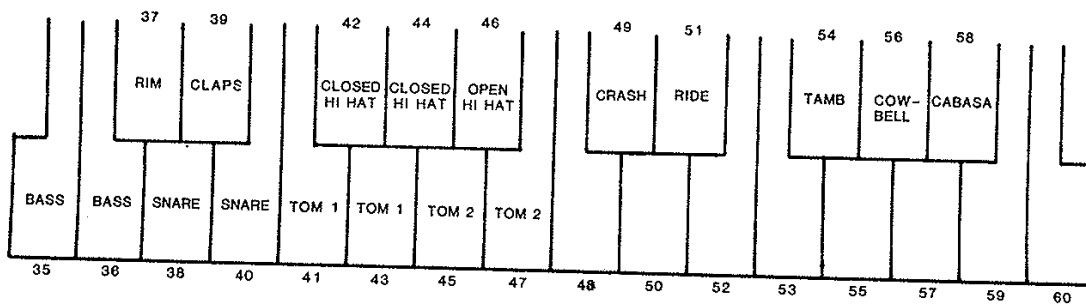

Figure 11-2
MIDI KEYBOARD INSTRUMENTS

Duplicate keys are provided for creating fast, realistic rolls--something that is impossible with the Drumtraks instrument keys alone.

When a velocity-sensitive synthesizer (such as SCI's Prophet-T8) is connected, its keyboard can be used to control the instrument volumes over the range covered by the PER INSTRUMENT VOLUME control. (In other words, accents can still be overdubbed.)

11 USING MIDI

11-3 Using Two Drumtraks

To explain how the Drumtraks MIDI functions, in this paragraph we'll take the example of two 400s interconnected with MIDI.

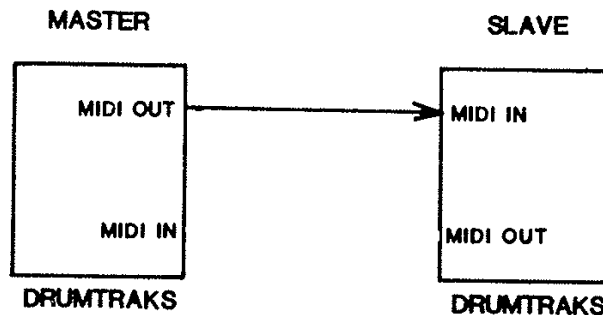

Figure 11-3
400 DUAL CONTROL

The "master" is the primary Drumtraks from which the control selections are made.

Assuming power has just been turned on:

Key Events

The master will not send its instrument key events to the slave unless you specifically enable this function, by:

Hold ENTER, press 4.

To switch off key event transmission:

Hold ENTER, press 5.

Whether you enable key events or not depends on what you are doing. If recording on the slave, you may or may not want key events from the master recorded.

Song Select

When a song is selected on the master, the slave (if stopped) will switch to the same song. Also, if the slave happens to have been in pattern mode, it will switch to song mode.

Run/Stop

If the slave is in song mode, when a pattern or song is started on the master, the slave will start.

(When the slave receives the start command, it automatically switches from any other selected clock to MIDI clock input.)

When the master stops or is stopped, the slave will stop.

(When the slave is stopped, it ignores MIDI clock inputs.)

11 USING MIDI

Program Dump

A Drumtraks program is the set of all pattern and song data. There is an operation which is used to transfer programs between Drumtraks units.

To load a pattern from the master to the slave, on the slave:
Hold ENTER, press 3.

This causes the slave to send a program dump request to the master. The master will respond by sending the entire contents of its memory to the slave (erasing the slave's former program).

11-4 Use with Sequencer

The Drumtraks can be connected to the Model 610 Six-Trak, so multi-timbre sequences record, overdub, and playback with the Drumtraks in synchronization.

The SCI Model 64 contains one set of MIDI connectors for use with a MIDI synthesizer. Rather than with MIDI, the Drumtraks interfaces to the Model 64 by way of the 24- or 48-PPQN clock interface. Since the Drumtraks contains its own extensive memory and editing facilities, the MIDI sequencer is not needed.

However, super-sequencers will inevitably appear that will link all MIDI instruments into one programmable system. In addition to the MIDI functions discussed above, the following applies to operation in future MIDI systems:

Mode

When power is switched on, the Drumtraks is set to Omni On mode. In this mode, it will ignore any channel designations, playing all received key events in the range of keyboard numbers to which it is sensitive (see Figure 11-2 for key numbers).

If the master sequencer sends an Omni Mode Off command to the Drumtraks, the Drumtraks will then listen for key events only on the MIDI channel to which it is set.

Channel

When it leaves the factory, the Drumtraks basic channel is set to Channel 15.

To display the channel number:

Hold both ENTER and 0.

To change the channel number:

While holding ENTER and 0, select channel (1-16) with INC/DEC.

If the channel number is changed it will remain changed even if power is switched off.

MIDI Clock

When a slave Drumtraks receives a start command over MIDI, it automatically switches itself to receive MIDI clocks. This switching can also be done manually:

Hold both TEMPO switches.

Press ENTER.

Press DEC three times, to move the decimal point all the way Left.

To switch back to internal clock mode, press ENTER again. (The decimal point will go off.)

12 DISPLAY SUMMARY

While operating the Drumtraks you will see several kinds of messages in the Left and Right displays. The message type is determined by the current mode of operation, which is indicated by one of the FUNCTION LEDs.

The various display formats are summarized below. For more information please refer to the appropriate paragraph in this manual.

PATTERN MODE

PATTERN

This display appears when power is switched on. Note that PATTERN # is on. It means that you are in PATTERN # mode and the first pattern (#00) is selected. Pattern numbers are always displayed on the Right.



ERASE INSTRUMENT

The display looks like this when ERASE INSTRUMENT is on. It means that pressing any instrument key will erase that instrument from the pattern. (When erasing an entire pattern, this message does not appear.)



ERROR CORRECT

When ERROR CORRECT is on, the display looks like this. The Right display shows the note value selected for error correction.



ERROR CORRECT
SYMBOL



VALUE

SWING %

When SWING % is on, the display looks like this. The Right display shows that the current swing value is 50%. To select other values, use INC/DEC.



SWING %

12 DISPLAY SUMMARY

TIME SIGNATURE

When TIME SIGNATURE is on, the display looks like this. This example shows that the current time signature is 4/4.



OF MEASURES

When # OF MEASURES is on, the display looks like this. In this example, the pattern length is one measure. Patterns can be up to 99 measures long.



SONG MODE

SONG

When SONG # is on, the display looks like this. In this example, song 00 is selected.



BUILD MODE

The following displays are only seen when BUILD MODE (under SELECT SONG FUNCTION) is on.

Empty Song

A display such as this indicates the first step of the selected song is an "Ending." (Both BUILD MODE and PATTERN # are on.)



1st STEP



END SYMBOL

Built Song

If the song has been built, the Left display shows that you are looking at the first step of the song. The Right display shows that this step is pattern #35. (Both BUILD MODE and PATTERN # are on.)



1st STEP



PATTERN #

12 DISPLAY SUMMARY

Song Ending

In this example, the display shows that the fifth step of the song is the "Ending." (Both BUILD MODE and PATTERN # are on.)



5th STEP
(REMEMBER, 00 IS THE
1st STEP LOCATION)



END SYMBOL

Tempo Change Step

In this example a TEMPO CHANGE is shown at the second step of the song. The TEMPO CHANGE symbol is displayed on the Right at every step where a tempo change is programmed. Both BUILD MODE and PATTERN # are on. The direction and amount of the change is only shown when TEMPO CHANGE is on (see below).



2nd STEP



TEMPO CHANGE
SYMBOL

Volume Change Step

In this example a VOLUME CHANGE is shown at the third step of the song. The VOLUME CHANGE symbol is on the Right at every step where a volume change is programmed. Both BUILD MODE and PATTERN # are on. The direction and amount of the change is only shown when VOLUME CHANGE is on (see below).



STEP #



VOLUME
SYMBOL

Tempo Change Direction and Value

When BUILD MODE and TEMPO CHANGE are on, the TEMPO CHANGE symbol is moved to the Left display, which also includes an "arrow" pointing up or down for the direction of the change. The Right display will show the amount of the change in tempo values.



TEMPO
INCREASE
SYMBOL



RELATIVE
AMOUNT

(OR)

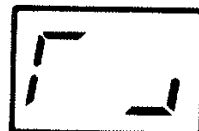

TEMPO
DECREASE
SYMBOL



RELATIVE
AMOUNT

12 DISPLAY SUMMARY

Volume Change Direction and Value
When BUILD MODE and VOLUME CHANGE are on, the VOLUME CHANGE symbol is moved to the Left display, which also includes an "arrow" point up or down for the direction of the change. The Right display will show the amount of the change in volume values.



VOLUME
INCREASE
SYMBOL



RELATIVE
AMOUNT

(OR)



VOLUME
DECREASE
SYMBOL



RELATIVE
AMOUNT

Tempo Display

This display appears when both the TEMPO SLOWER and FASTER switches are held.



TEMPO
SYMBOL



BEATS PER
MINUTE

(RANGES FROM 40-250
BEATS PER MINUTE)

13 HIDDEN FUNCTIONS

In addition to normal control operations, certain lesser-used options are available by using the controls in other than normal ways. Some of the hidden functions have already been discussed. This section gathers them all together:

Memory Remaining

Hold INC/DEC simultaneously.
Read % remaining in left display.

Clear All Memory

Hold 7, 8, 9, INC, and DEC simultaneously.

Playback Clock Input

Hold both TEMPO switches.
Press ENTER.
To select clock, use INC/DEC:
Display decimal points:

MIDI 96 48 24

Playback Clock Output

If there is an external clock input, clock output is disabled.

Hold ENTER.
For 24 PPQN square wave, press 1.
For 48 PPQN (20 microsecond), press 2.

Program Dump Request

Do the following to send a MIDI program dump request. If a MIDI device recognizes the request, it will dump a program (a set of patterns and songs) to the 400.

Hold ENTER.
Press 3.

MIDI Channel Select

Hold ENTER.
Press 0.
Read current channel number in display.
To select new channel (1-16), while holding ENTER and 0, use INC/DEC.

Enable Pads Out MIDI

Hold ENTER.
Press 4.

Disable Pads Out MIDI

Hold ENTER.
Press 5

Clock Test

For service only. ENTER + 8 connects CLOCK IN to CLOCK OUT. Halts if bad.

MIDI Test

For service only. ENTER + 7 connects MIDI IN to MIDI OUT. Halts if bad.

14 DETAILS

Accent In conjunction with an instrument key, the ACCENT switch is of course used to emphasize a part. While emphasis can also be programmed using PER INSTRUMENT VOLUME, this uses much more memory than does the ACCENT switch.

Append To create a new pattern by adding one pattern to the end of another.

Copy To record an existing pattern or song under a second number.

Pattern copying can be a very handy tool. For example, you can have a set of basic patterns which can be copied to form the basis of more varied overdubs. As opposed to making a song of twelve identical patterns, you can easily generate twelve variations of one basic pattern.

CLK IN/OUT A pre-MIDI interface system for sequencers and rhythm units. The Drumtraks has a switchable 24, 48, or 96 pulse per-quarter-note (PPQN) input and a 24 or 48 PPQN output (see paragraph 10-1). Other units may (or may not) operate from 16 to 96 clocks per quarter note.

CLOCK OUT is used to interface with the Model 64 Sequencer, as shown in Figure 10-2.

Erase Instrument A feature which can be used to delete all or part of an instrument from a pattern (regardless of tuning). To erase selectively, hit the instrument key on (or just slightly before) the undesired note. To completely erase an instrument, hold its key throughout the pattern loop.

In RECORD MODE, this feature can be used to "thin out" a pattern which is being recorded (on tape). (If tape recording from AUDIO OUT with the Drumtraks in RECORD MODE, you would probably turn METRONOME VOLUME all the way down.)

Error Correct This feature allows you to create perfectly-timed patterns. Error correct ranges from 1/2 to 1/96, in ten values: 1/2, 1/4, 1/6 (quarter triplet), 1/8, 1/12 (eighth triplet), 1/16, 1/24 (sixteenth triplet), 1/32, 1/48, 1/96.

For example, error correct is set by default to 1/16. This means that as you record or overdub parts, the Drumtraks will only allow notes to fall exactly on sixteenth-note beats.

With a value of 1/2, all "real-time" parts would be corrected to one of two places in the (4/4) measure. At the other extreme, a value of 1/96 would provide 96 recording points in the measure, which is virtually the same as "real-time." INC raises value, DEC lowers it.

While editing or overdubbing it is often useful to adjust the error-correct value to the way the instrument is used. For example, usually one overdubs percussion parts from

lowest to highest. Use the lowest resolution for each part. Thus before recording the bass drum or snare you might set error correct to 1/4 or 1/8, to obtain a precise foundation. Then you might raise the value to 1/16 or 1/32 before adding any faster rhythms which you may not want to lie exactly on a beat, but played more nearly as you play them.

Error correct only affects current recording, it has no effect on previously-recorded parts.

Loop Each repetition of a pattern. Overdubbed parts are heard recorded in the next loop.

MIDI Musical Instrument Digital Interface. An emerging standard for interfacing computer-based musical instruments.

NEXT Footswitch In pattern mode, this footswitch can be used to obtain precise ending of a pattern, if the "next" pattern which it cues up is empty.

Overdub Editing a pattern by adding instrument parts.

Pattern Segments of percussion music which can be modified, copied, and linked together by step instructions into a song.

For use as stop function, pattern #99 is always blank. Cueing it will cause the current pattern to stop at its exact end.

The following pattern attributes are recorded in non-volatile memory:

- number of measures
- number of beats per measure (time signature "numerator")
- beat value (time signature "denominator")
- error correct value
- swing value
- instrument notes
 - time the note occurs
 - accented or not
 - which instrument
 - instrument volume
 - instrument pitch
- pattern ending

Real-Time Actual playback or recording tempo.

Song A set of steps which perform pattern, tempo, or volume changes.

For use as stop function, song #99 is always blank. Cueing it will cause the current song to stop at the exact end of its last pattern.

The following song attributes are recorded in non-volatile memory:

- initial tempo, if any
- step type and value, can be:
 - pattern number
 - relative volume change
 - relative tempo change
 - empty
- end

Step An instruction which builds a song. A song can have up to 100 steps.

Swing Swing is a playback function only. However, the swing value is recorded with the pattern so that each time the pattern is selected, it will always play with the previously-selected swing value.

On playback of patterns with a beat value of a quarter note ($3/4$, $4/4$, $5/4$, etc.), by varying the swing value you can change the syncopation of the eighth notes. Swing represents a change in emphasis off of the precise eighth-note beat.

The Drumtraks swing value is set by default to 50%. This means that the two eighth notes which make a quarter note have equal time. In other words they play exactly as written. Swing can be adjusted to 54, 58, 62, 66, or 70%. By changing the swing value, for example, to 66%, the first eighth note would be lengthened from $1/2$ to $2/3$ of a quarter note and the second would be shortened from $1/2$ to $1/3$ of the same duration.

In a song, selecting patterns with different swing values helps break up the monotony of perfect rhythm. (In this way it is the opposite of Error Correct.) Note that in a song, to change the swing of a pattern, you would actually first copy the pattern, change the swing of the copy, then in the song, select the original pattern then the copy.

Tempo Number of beats-per-minute (bpm). The Drumtraks ranges 40-250, with the values shown in the chart on page 7-9.

The maximum value for a single tempo change step is plus or minus 15. Therefore for tempo changes greater than this, simply put two or more successive tempo change steps into the song.

Although usually irrelevant to most drum machine work, it is sometimes handy to have at hand the classical names for tempo ranges:

Largo	40-60
Larghetto	60-66
Adagio	66-76
Andante	76-108
Moderato	108-120
Allegro	120-168
Presto	168-200
Prestissimo	200-208

Time Signature Time signature can only be recorded when the pattern is erased. You can't change the time signature after a pattern is recorded. When copying a pattern, the time signature of the pattern being copied becomes the time signature of the copy.

Volume There are many sources of volume control. This is to explain how each of these sources are weighted.

The final volume of each instrument ranges from 0 (off) to 255 (maximum loudness). These values are "final volume units."

PER INSTRUMENT VOLUME adjustment covers the range 0-175. Each PER INSTRUMENT VOLUME level displayed (00-15) is actually equivalent to eleven final volume units.

The ACCENT key adds 80 final volume units to the PER INSTRUMENT VOLUME setting. Therefore ACCENT works even if the PER INSTRUMENT VOLUME is maximum (because $175 + 80 = 255$).

In a song, programmed volume changes operate over a range of +/-128 final volume units. In other words, each of the 32 song volume change levels (+/-16) is equivalent to eight final volume units.

When MIDI velocity input is present, it covers the range of PER INSTRUMENT VOLUME (0-175), also in sixteen levels of eleven final volume units each. This allows MIDI-input notes to be accented.

MASTER VOLUME is a passive, analog control, covering the full range.

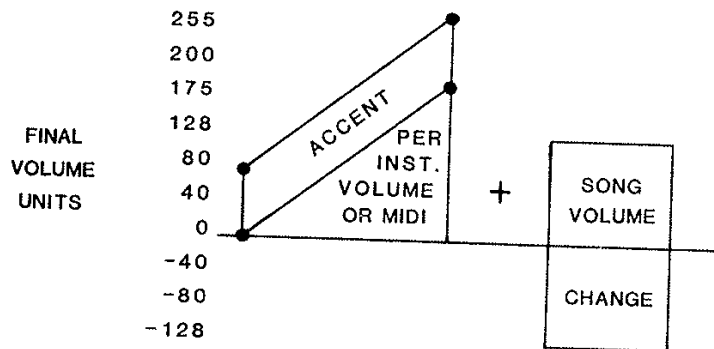

15 SPECIFICATIONS

General description

Fully programmable.

Non-volatile digital sequencer.

Thirteen actual percussion sounds stored in ROM.

Individual instrument volume and tuning controls.

Maximum capacity of 3289 notes.

Two basic modes: pattern and song. Patterns are chained together to form songs.

Cassette interface for non-volatile memory storage.

Clock interface (Input: 24, 48, or 96 PPQN. Output: 24 or 48 PPQN) for synchronization to sequencers, synthesizers, tape, or other drum machines

MIDI for external triggering, synchronization, and song selection.

Dual footswitch control.

Instruments

Channel 1	Bass
Channel 2	Snare Rim
Channel 3	Tom 1 Tom 2
Channel 4	Crash Cymbal Ride Cymbal
Channel 5	Closed Hi-Hat Open Hi-Hat
Channel 6	Claps Tambourine Cowbell Cabasa

Each instrument has its own performance key.

Instrument levels are accentable and individually programmable.

Instruments are mixed monophonically to the AUDIO OUT jack.

Only one instrument in each channel can be played simultaneously.

Each channel has a separate output jack.

Pattern functions

Real-time recording and overdubbing of instrument keys or MIDI input.

Programmable instrument mix.

Programmable instrument tuning.

Programmable accent.

Programmable swing

Programmable time signature:

Beats-per-measure

Beat notes

Six "feels": 50, 54, 58, 62, 66, 70 %

1-99, infinitely variable

1/2, 1/4, 1/6 (quarter triplet), 1/8,

1/12 (eighth triplet), 1/16, 1/24 (sixteenth triplet), 1/32

Error-Correct:

1/2, 1/4, 1/6, 1/8, 1/12, 1/16, 1/24, 1/32,

1/48, 1/96

Maximum number of patterns:

99

Maximum length:

100 measures

15 SPECIFICATIONS

Pattern Functions, cont'd

Metronome/click track:

Plays on beat note of time signature.
Mixed into AUDIO OUT during record.
Separate volume control. Separate output jack.
RUN/STOP blinks on first beat of pattern
Metronome accent during record.
Selective or entire part.

Downbeat indication:

A pattern can be copied to itself.
Loop, or auto-start new pattern
Controls playback
Cues next pattern

Erase

Copy

Append

Ending:

Run/Stop footswitch:

Next/Repeat footswitch:

Song functions

Programmable initial tempo:

40-250 beats per minute

Maximum number of songs:

99

Maximum number of song steps:

100

Programmable relative tempo change.

Programmable volume change.

Downbeat indication:

RUN/STOP blinks on first beat of pattern

Erase song

Copy

Append

Insert:

Delete:

Run/Stop footswitch:

Pattern, Volume change, Tempo change
Pattern, Volume change, Tempo change
Controls playback
Repeats current pattern

Next/Repeat footswitch:

Inputs

All jacks (except MIDI) are 1/4-inch phone, tip-sleeve.

CASS/CLK

For cassette verify and loading, or receiving
24, 48 or 96 pulse/quarter note sync from
tape clock.
Rising edge.
1.5V

Clock polarity

Sensitivity

RUN/STOP FTSW

Compatible footswitch when up is normally
open, when down closes tip to sleeve.
Duplicates RUN/STOP switch.

NEXT/REPEAT FTSW

Compatible footswitch when up is normally
open, when down closes tip to sleeve. Cues
next pattern or song, or, in a song, makes
current pattern repeat.

MIDI

5-pin DIN. Allows synchronization, remote
song selection, or instrument triggering.

15 SPECIFICATIONS

Outputs

AUDIO 1/4-inch phone, tip-ring-sleeve. Can drive stereo headphones with mono signal.
1K, dc-coupled

MIDI 5-pin DIN.

The following jacks are 1/4-inch phone, tip-sleeve.

CH 1 - 6 Individual outputs for each channel.
1K, ac-coupled with 10 uF

MET dc-coupled. Output during playback only. Used as programmable low-speed clock.

CASSETTE ac-coupled. For cassette saving or sync-to tape. Output during playback only.
Clock rate 24 PPQN square wave, or 48 PPQN pulse.
Clock amplitude 5 Vpp

CLOCK dc-coupled. For syncing to other devices.
Clock rate 24 PPQN square wave, or 48 PPQN pulse.
Clock amplitude 5 Vpp

MIDI functions

Note On, each instrument, velocity divided to 16 volume levels. (Allows external triggering of instruments from synth keyboard or pads.)

Mode control: Defaults to Omni mode. Can be switched to Poly mode.

Song Position Pointer

Song select

Timing clock

Start

Stop

Continue

System Reset

Other

Memory remaining display

Memory full warning

Memory percentage remaining function

1-year warranty

Power 110-125V: 1/2A slo-blo fuse.
220-240V: 1/4A slo-blo fuse
10-year backup battery

Dimensions:
Height 4 in.
Width 21-3/8 in.
Depth 10 in.

400 DRUMTRAKS MIDI IMPLEMENTATION

December 17, 1983

Unless otherwise specified, status/data bytes are given in binary, while numbers in descriptions are in decimal.

TRANSMITTED DATA

Status	Second	Third	Description	
1001 nnnn	0kkk kkkk	0vvv vvvv	Note On. Only sent when enabled. (See page 3.)	
			kkk kkkk = K (For key values, see Table 1.)	
			vvv vvvv (Velocity) = 1 - 127, depending on programmed volume only (accent and song volume changes are ignored).	
	0kkk kkkk	0000 0000	Note Off. All Note Ons are followed immediately with a Note Off (V = 0), with no new status byte, i.e., five bytes sent for each pad played.	
1111 0011	0sss ssss		Song Select. When song is selected, that song number (S = 00 - 99) is sent.	
1111 1010			Start. When playback of any song or pattern starts, this is sent immediately before the first Timing Clock.	
1111 0000 (SYS EX	0000 0001 SCI ID	0111 1111 PM	1111 0111 EOX)	Pattern Marker. Sent immediately after the first Timing Clock of each pattern, except at the start of a song or pattern.
1111 1000			Timing Clock. During playback of any song or pattern, this is sent at 24 per-quarter-note rate.	
1111 1100			Stop. Sent whenever a song or pattern is stopped.	

TRANSMITTED DATA

Status	Second	Third	Description
1111 0000 (SYS EX	0000 0001 SCI ID	0000 0110 400 ID	data 1111 0111 Program Dump. EOX) data is 7680 song and pattern data bytes, formatted as 15,360 four-bit nibbles, right justified, LS nibble sent first. For data packing information, see Tables 2 through 6.

RECOGNIZED RECEIVED DATA

1001 nnnn 0kkk kkkk 0vvv vvvv Note On.

nnnn = Channel number. This is ignored if Omni On mode, and checked for match with channel number in Omni Off mode.

kkk kkkk, (For key values, see Table 1.)

vvv vvvv (Velocity) = 1 - 127

vvv vvvv = 0, Note Off is ignored, as are all Note Offs.

1111 0011	0sss ssss		Song Select. Switches to song mode and selects song # (must be 00-98). Also must already be in either song stop or pattern stop modes.
1111 1010			Start. Only if in song mode, starts playback from start of current song. Selects MIDI playback clock.
1111 1000			Timing Clock. Recognized whenever in playback of a song or pattern, and MIDI clock is selected (either by front panel or by Start status.)
1111 1100			Stop. Stops song playback. MIDI clock inputs are ignored.
1111 nnnn	0111 1100		Omni Mode Off.
1111 nnnn	0111 1101		Omni Mode On.

RECOGNIZED RECEIVED DATA, cont'd

Status	Second	Third		Description
1111 0000 (SYS EX	0000 0001 SCI ID	0000 0000 REQUEST ID	1111 0111 EOX)	Program Dump Request. This will initiate a complete program dump of song and pattern data. See Tables 2 through 6.
1111 0000 (SYS EX	0000 0001 SCI ID	0000 0110 400 ID	data 1111 0111 EOX)	Program Dump Receive. data is 7680 song pattern data bytes, formatted as 15,360 four-bit nibbles, right justified, LS nibble sent first. See Tables 2 through 6.

CODED FUNCTIONS

Select MIDI Clock

1. Hold both TEMPO switches.
2. Press ENTER.
3. Press DEC three times, to move the decimal point all the way Left.
4. To switch back to internal clock mode, repeat steps 1 and 2. (The decimal point will go off.)

Enable Pad Out

To enable sending pad information (Note On), hold ENTER and press 4.

To disable sending pad, hold ENTER and hit 5.

Mode Select—Receive Only

The 400 always powers-up with Omni Mode On: the Basic Channel is set to 15 (N = 1110) at the factory.

The channel can be changed from the front panel by:

1. Hold both ENTER and 0. This will display the current channel number.
2. Select new channel number, if desired, using INC/DEC (1 through 16).

The channel is ignored with Omni Mode On and checked with Omni Mode Off. The Mode Change commands must be sent to the correct channel in either mode.

The channel number is non-volatile, that is, if the channel number is changed it will remain changed even if power is switched off.

TABLE 1
400 MIDI KEY ASSIGNMENTS

kkk kkkk = 35 - 58, instrument keys
 (36 = lowest C on keyboard, see Figure 1.)

35, 36	BASS
37	RIM
38, 40	SNARE
39	CLAPS
41, 43	TOM 1
42, 44	CLOSED HI-HAT
45, 47	TOM 2
46	OPEN HI-HAT
49	CRASH CYMBAL
51	RIDE CYMBAL
54	TAMB
56	COWBELL
58	CABASA

Transmit: Keys 36, 40, 43, 44, and 47 are sent for the duplicated sounds.

Receive: Keys not listed are ignored.

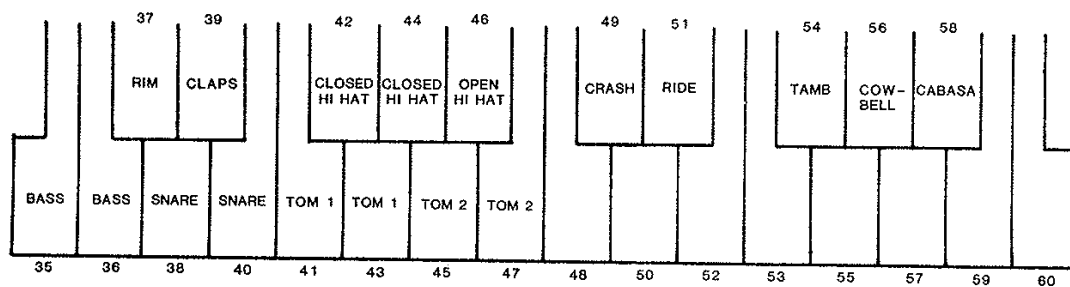

Figure 1
MIDI External Keyboard Percussion Keys

TABLE 2
400 Data Dump Format

<u>Bytes (Hex)</u>	<u>Description</u>
00 - C7	Song Pointers (see Table 3).
C8 - 18F	Pattern Pointers (see Table 4).
190 - 191	Pointer to Space After Song 99.
192 - n	Song Data (see Table 5).
n+1 - m-1	unused memory
m - 1DFF	Pattern Data (see Tables 6 and 7).

A dump in the 400 dumps all pointer tables, song data, pattern data, and unused memory. All data must be maintained correctly, or the 400 could "crash" (for example if song or pattern pointers are not updated when changes are made in the lengths of songs or patterns).

TABLE 3
Song Pointers

<u>Bytes (Hex)</u>	<u>Description</u>
0 - 1	Pointer to Song 00. Always equals 2392H. Pointer stored in LS - then -MS format.
2 - 3	Pointer to Song 01.
"	"
"	"
C6 - C7	Pointer to Song 99.

Note: Data memory for songs and patterns is from 2392H through 3FFFH, with songs at the start, patterns at the end, and unused memory in the middle.

TABLE 4
Pattern Pointers

<u>Bytes (Hex)</u>	<u>Description</u>
C8 - C9	Pointer to Pattern 00. Pointer is stored in LS - then - MS format.
CA - CB	Pointer to Pattern 01.
"	"
"	"
18E - 18F	Pointer to Pattern 99.

TABLE 5
Song Data

Relative Byte Number	Byte	Description
0	0ttt tttt or 1000 0000	T = 0-127, initial absolute tempo for this song. no initial tempo
steps	0ppp pppp or 100v vvvv	P = 0-99, pattern number V = +/-15, relative volume change
	101t tttt or 1110 0000	T = +/-15, relative tempo change Empty Step (deleted, but not reprogrammed)
END	1100 0000	End of Song.

Note: An empty song will still have two bytes programmed: the initial tempo (byte 0) and the END byte.

TABLE 6
Pattern Data

Relative Byte Number	Byte	Description
0	d2nnn nnnn	N = 1-99, number of beats per-measure ("numerator" of time signature)
1	d1sss eeee	E = 0-9, Error Correct (see Table 7) S = 0-5, Swing (see Table 7)
2	d0mmm mmmm	M = 1-99, Number of Measures D = 0-7, beat value (see Table 7) ("denominator" of time signature)
(event storage)		
two-byte event (normal)		
	tttt tttt 00EA dddd	T = 0-255, Time (1/96 note, 24 PPQN) E = clock extend (time overflow) A = Accent on/off D = Drum number (see Table 7)
three-byte event (dynamic)		
	tttt tttt 01EA dddd vvvv pppp	same as above V = 0-15, Volume for this event P = 0-15, Pitch for this event.
END	tttt tttt 1000 xxxx	Time for End X = don't care

Note: An empty pattern will still have five bytes programmed: the three-byte prologue and two-byte END.

TABLE 7
Miscellaneous Parameter Tables

Error Correct

<u>Value</u>	<u>Note</u>
0	1/2
1	1/4
2	1/6
3	1/8
4	1/12
5	1/16
6	1/24
7	1/32
8	1/48
9	1/96

Swing

<u>Value</u>	<u>%</u>
0	50
1	54
2	58
3	62
4	66
5	70

Beat Note (denominator)

<u>Value</u>	<u>Note</u>
0	1/2
1	1/4
2	1/6
3	1/8
4	1/12
5	1/16
6	1/24
7	1/32

Drum Number

<u>Number</u>	<u>Drum</u>
0	BASS
1	SNARE
2	RIM
3	TOM 1
4	TOM 2
5	CRASH CYMBAL
6	RIDE CYMBAL
7	CLOSED HI-HAT
8	OPEN HI-HAT
9	CLAPS
10	TAMB
11	COWBELL
12	CABASA

SEQUENTIAL CIRCUITS, INC. LIMITED WARRANTY

Please read this warranty as it gives you specific legal rights. You may also have other rights which can vary from state to state.

LENGTH OF WARRANTY

This warranty will remain in effect for one year from the date of purchase.

WHAT IS COVERED

This warranty covers all defects in material and workmanship in this product, under the condition as discussed in the following sections.

WHAT IS NOT COVERED

- 1) Damage due to accident, misuse, neglect, or abuse - including damage resulting from failure to follow instructions contained in the operation manual.
- 2) Damage or deterioration of cabinet or keyboard.
- 3) Damage occurring during any shipment of the product for any reason. All claims must be handled directly with the carrier.
- 4) Damage resulting from repair or attempted repair by anyone other than Sequential Circuits, Inc. (S.C.I.) or an authorized S.C.I. Service Center.
- 5) Any unit on which the serial number has been obliterated, modified, or removed is not covered under this warranty.
- 6) Any modification or alteration of any kind performed by anyone including S.C.I. or an Authorized S.C.I. Service Center will void the warranty on your unit. The only exception to this is an Authorized S.C.I. modification which includes its own warranty coverage. Due to the complexity of the circuitry, modifications tend to create repair units and therefore increase repair costs.

HOW TO VALIDATE THE WARRANTY

With this warranty you will find a Warranty Registration Card. This card is to be filled out and returned to S.C.I. within 10 days of the date of purchase.

The warranty is applicable to the original purchase only and you must present the original purchase receipt to obtain warranty performance, unless applicable laws state otherwise.

HOW TO OBTAIN WARRANTY PERFORMANCE

Your unit may be serviced by any Authorized S.C.I. Service Center if you are unable to find a service center in your area please contact the S.C.I. Factory Service Department. We will either refer you to an Authorized Service Center or request that you return your unit to the factory. If you are to return your unit to the factory, you will be given a Return Authorization Number. Please mark all packages and shipping documents with this number.

Do not return your unit to the factory without prior authorization as your unit may not be accepted.

You must pay all shipping charges to and from S.C.I. or Authorized Service Centers and you will be responsible for damage and/or loss resulting from shipment in either direction. If you desire a fully insured shipment you must arrange for this coverage with the carrier. If you wish your return shipment to be insured, you must request this in writing at the time your unit is delivered to S.C.I. All additional charges must be prepaid or your unit will be returned to you. O.D. details and costs can be obtained from the S.C.I. Shipping Department.

LIMITATIONS OF IMPLIED WARRANTIES

Any implied warranties, including warranties of merchantability and fitness for a particular purpose, are limited in duration to the length of the warranty.

EXCLUSION OF CERTAIN DAMAGES

S.C.I.'s liability for any defective product is limited to repair or replacement of the product at S.C.I.'s option. S.C.I. shall not be liable under any circumstances for:

- 1) Damages based upon inconvenience, loss of use of the unit, loss of time, interrupted operation or commercial loss.
- 2) Any other damages, whether incidental, consequential or otherwise, except damages which may not be excluded under applicable law.

Some states do not allow limitations on how long an implied warranty lasts and/or do not allow the exclusion or limitation of incidental or consequential damages, so the above limitations and exclusions may not apply to you.

March 6, 1981

Please fill in the following information for our Marketing Department. Thank you for your cooperation.

NAME _____

ADDRESS _____

CITY _____ STATE _____

ZIP _____ PHONE _____

MODEL _____ SERIAL NO. _____

DATE PURCHASED _____

PURCHASED FROM _____

AGE _____
 10-19 20-29 30-39 40-49 50-59 60-69 70-79 80-89 90-99

TYPE OF MUSIC PLAY
 Country Folk
 Jazz R&B
 Rock Soul
 New Wave Pop
 Other _____

TYPE OF MUSICIAN
 Student Professional Amateur
 Working Recording Session Studio
 Soloist Other _____

MUSICAL PUBLICATION
 Early Read and Rev
 Rolling Stone
 Guitar Player
 Downbeat
 International Musician
 Contemporary Keyboard
 Modern Player
 Other _____

INSTRUMENTS PLAYED
 Flute Woodwind Saxophone
 Clarinet Keyboard Guitar
 Bass Synthesizer Other _____

Do you own a computer? Yes No

WHAT INFLUENCED YOUR DECISION TO PURCHASE AN S.C.I. PRODUCT?

WHAT DO YOU LIKE MOST ABOUT YOUR S.C.I. PRODUCT? ADDITIONAL COMMENTS _____

WHAT OTHER PRODUCTS WOULD YOU LIKE S.C.I. TO CREATE?