

HiFi ENGINE®

For more Hi-Fi manuals and set-up information
please visit www.hifiengine.com

INTEGRATED STEREO AMPLIFIER

SA-9500

OPERATING INSTRUCTIONS

KCU

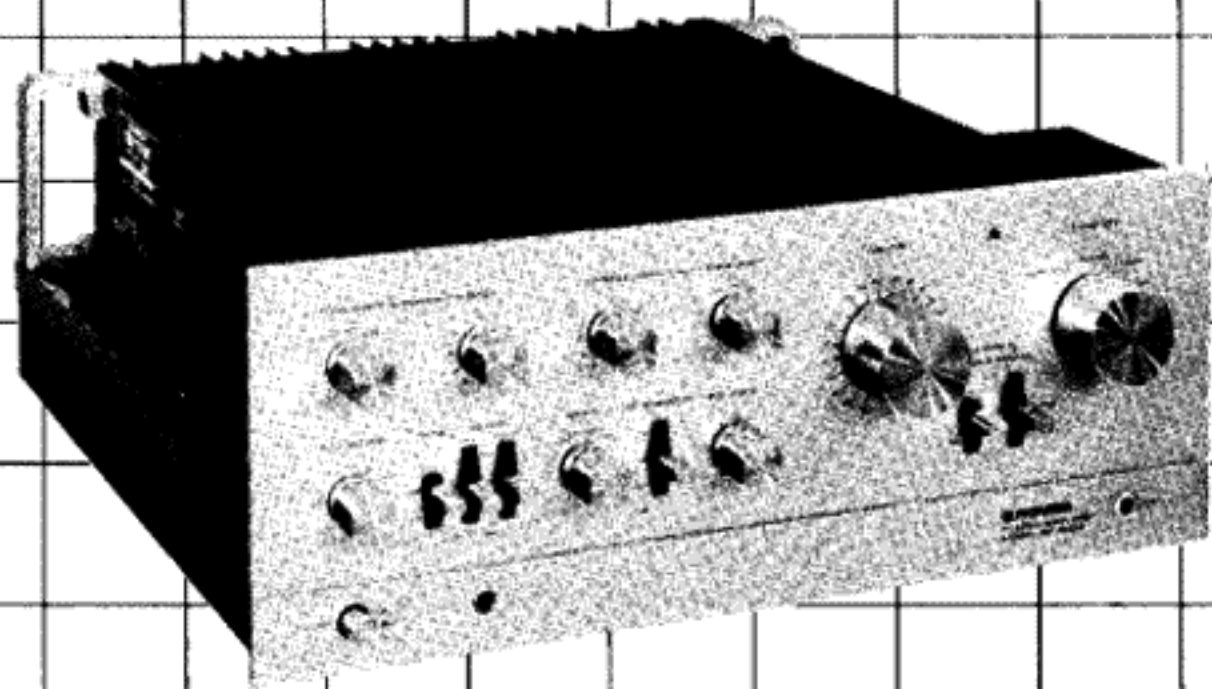

 **PIONEER**

WARNING: TO PREVENT FIRE OR SHOCK HAZARD,
DO NOT EXPOSE THIS APPLIANCE TO RAIN OR
MOISTURE.

CONTENTS

Features	2	Employing Tape Deck	11
Stereo System Composition	3	Effective Operation	12
Connection Diagram	4	Employing PRE OUT & POWER IN Jacks ..	14
Connections	6	Specifications	15
Front Panel Facilities	8	Conditions Frequently Mistaken for Malfunction	16
Before Operation	10		
Operation	10		

FEATURES

Ample Margin Power Amplifier

High reliability NPN and PNP silicon power transistors are employed together with a differential first stage. All stages are direct coupled in a pure complementary OCL circuit design. This combination of superior components and circuit design results in excellent frequency response and distortion characteristics, plus plenty of extra power for effortless sound reproduction.

Versatile Tone Control Section

TURN OVER switches are provided for the conventional BASS and TREBLE controls to allow selection of the frequencies at which the controls take effect. An important TONE switch is also included for obtaining flat frequency response at any time without regard to the tone control settings. System sound can be composed or evaluated according to cartridge, speaker, and listening room characteristics.

Precise RIAA Equalization

Ultra-precision grade metalized film resistors (sputtering process) and styrene capacitors are combined as equalized elements. Deviation from the RIAA curve has been reduced by $\pm 0.2\text{dB}$ in the frequency range of $30\text{Hz} \sim 15\text{kHz}$. An FET is employed in the 1st stage differential amplifier and by adopting a 3-stage direct coupled SEPP circuit, input impedance variation due to frequency is minimized. High stability is attained at low distortion, in addition to a greatly expanded acceptable input level. Distortionless disc reproduction can therefore be enjoyed, even with a high output cartridge and a dynamic music source containing large peak inputs.

All Program Sources can be Enjoyed

A full array of input jacks permits connection of 2 turntables, 2 tape decks, a stereo tuner, and 2 auxiliary components. Wide flexibility is provided for employing virtually any kind of program source.

Reliable Electronic Protection Circuit

In event of speaker shorting or malfunction in which DC is applied to the output, speakers and transistors are reliably guarded by an electronic protection circuit. This circuit also acts as a muting circuit when the power switch is turned on and off.

Accurate Volume Control Expands Adjustment Range

The Volume control is equipped with a precision attenuator of the type employed in measuring instruments and other high reliability equipment. Volume adjustment can be easily performed when listening at low volume levels, temporarily reducing the volume, or employing a low input level (high gain) power amplifier. The volume adjustment range can also be expanded by employing the volume control and attenuator switch in combination.

Phono 2 Jacks Provided with Impedance Selector & Level Control

A convenient impedance selector switch ($35\text{k}\Omega$, $50\text{k}\Omega$, $70\text{k}\Omega$, $100\text{k}\Omega$) and level control ($0 \sim -12\text{dB}$) are provided for the PHONO 2 jacks for matching cartridge output characteristics, comparison listening, etc.

Tape Switch for Easy Tape Duplication

By connecting 2 tape decks, the desired program only from a previously recorded tape can be edited and re-recorded. The Duplicate switch also lets open reel tape be duplicated onto cassette tape.

Audiophile Functions Incorporated

A PRE/POWER AMP selector switch plus PRE OUT and POWER IN jacks are included. An external power amplifier can be connected to the PRE OUT jacks to allow listening comparison and power amplification. This feature can also be employed for composing a multi-amplifier or 4 channel system. A single SA-9500 can thus be used to set up various kinds of audio systems.

STEREO SYSTEM COMPOSITION

- Do not place equipment in locations that are unlevel or subject to vibration.
- Allow for good rear panel ventilation of components; avoid humidity and dust.
- Keep equipment away from radiators or other heat sources.

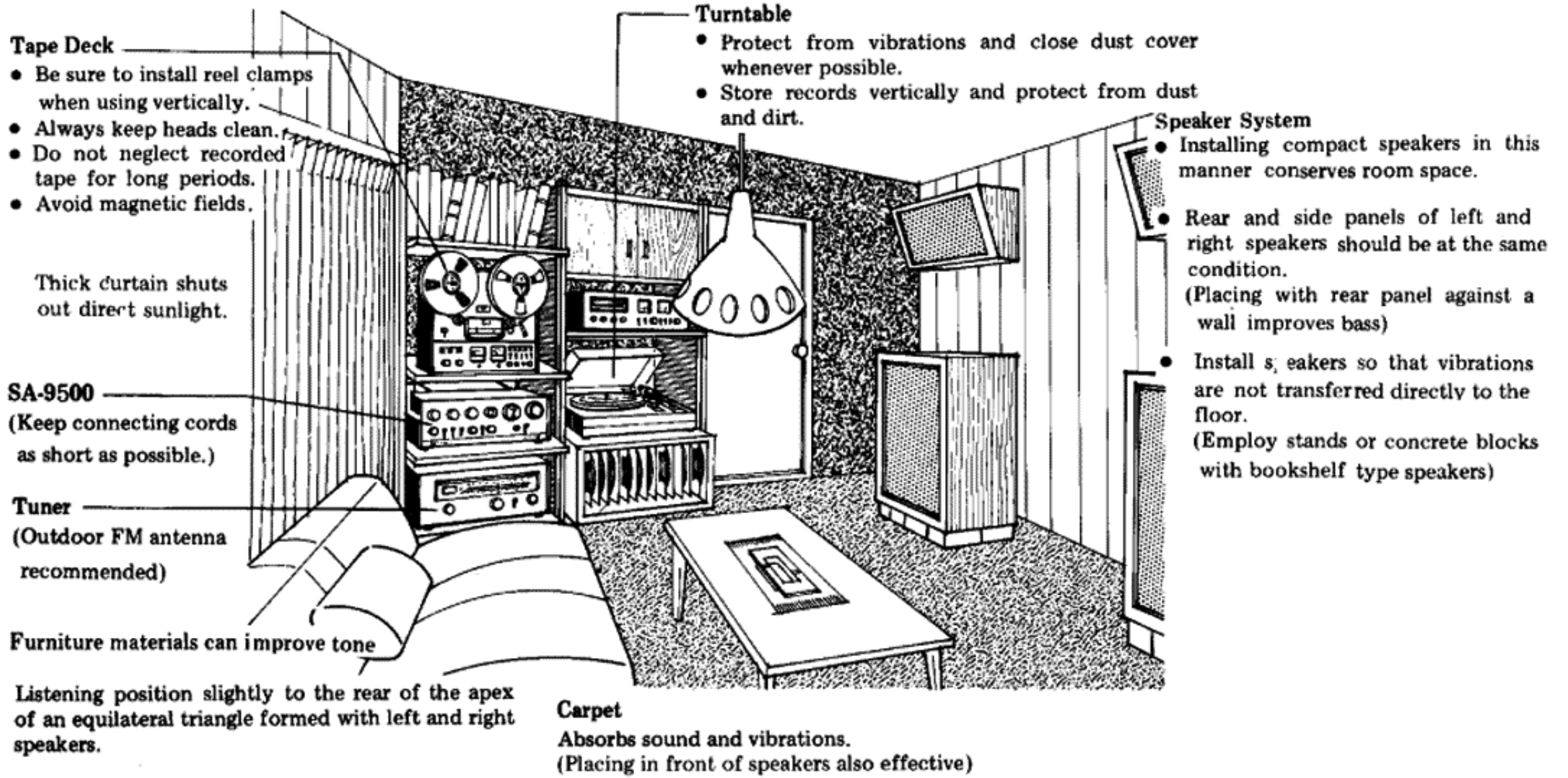

SA-9500 APPLICATION EXAMPLE

- Multi-Amplifier System

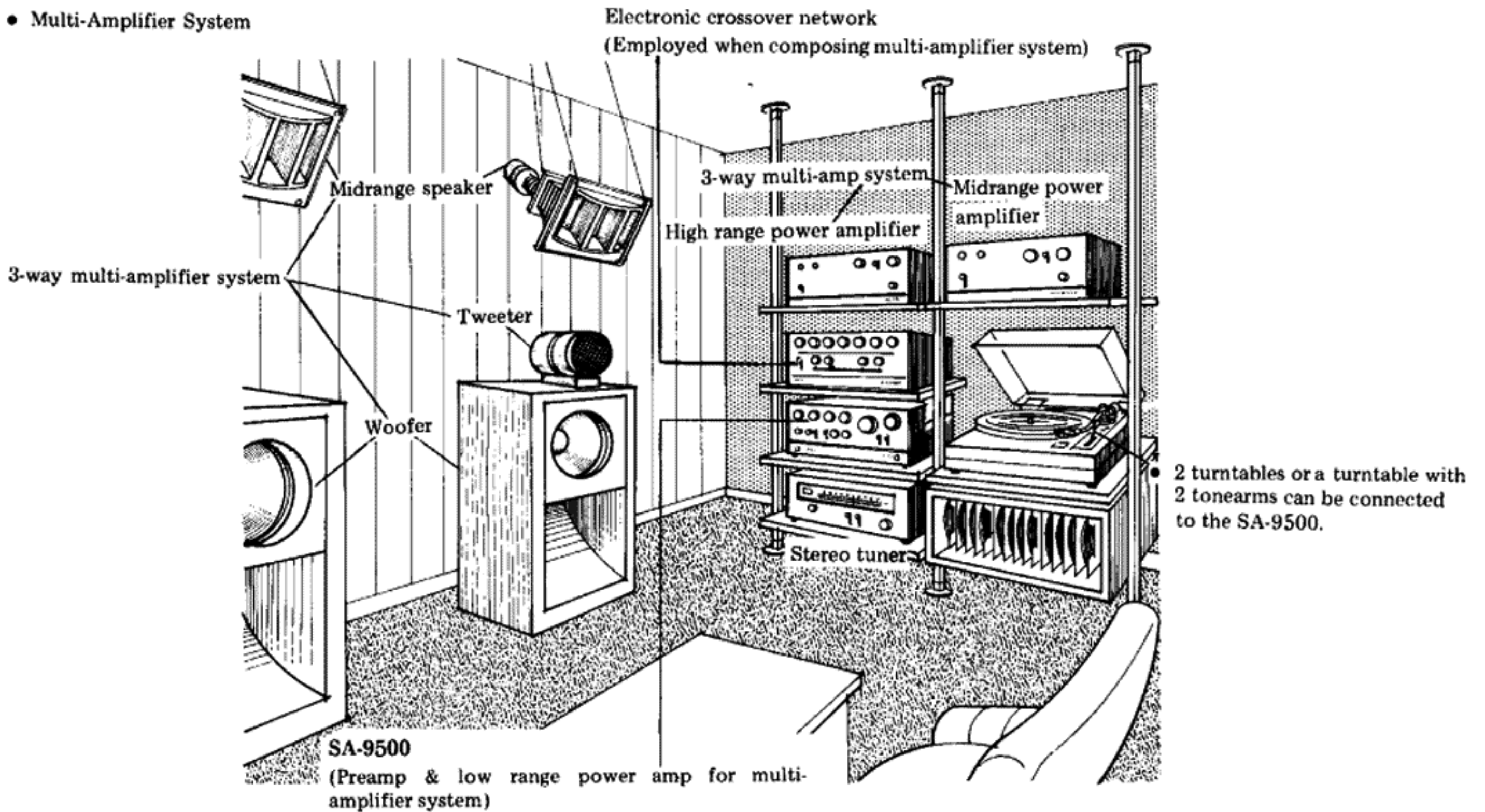

CONNECTION DIAGRAM

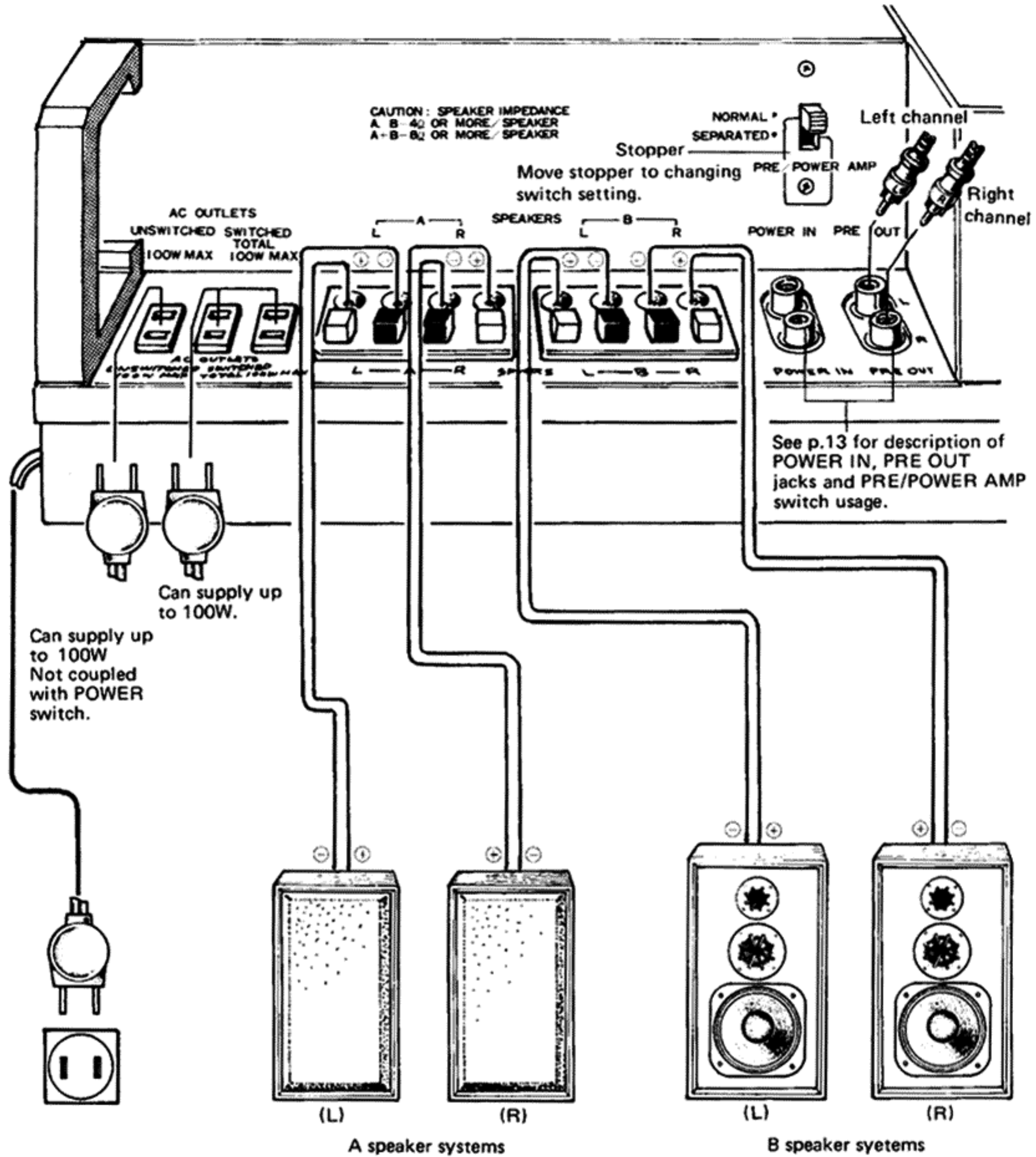

Cautions When Connecting

- Observe both the channels and polarities of the inputs and outputs of the components connected to the SA-9500. Be sure to connect L to L, R to R, + to +, and - to -.
- Make all connections securely. Loose connections can cause absence of sound or noise.

Install furnished covers on unused AC outlets, and input and output to protect from dust.

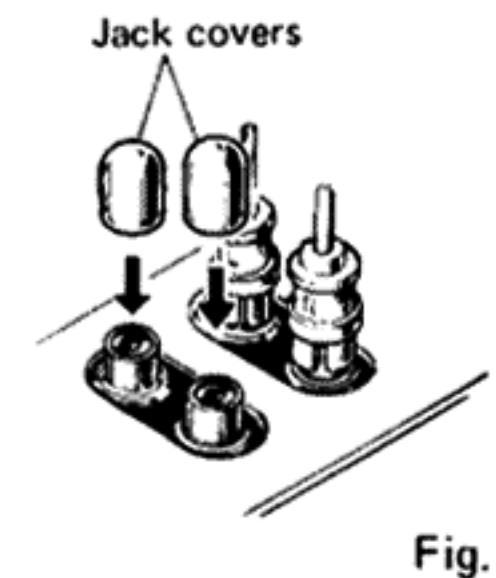
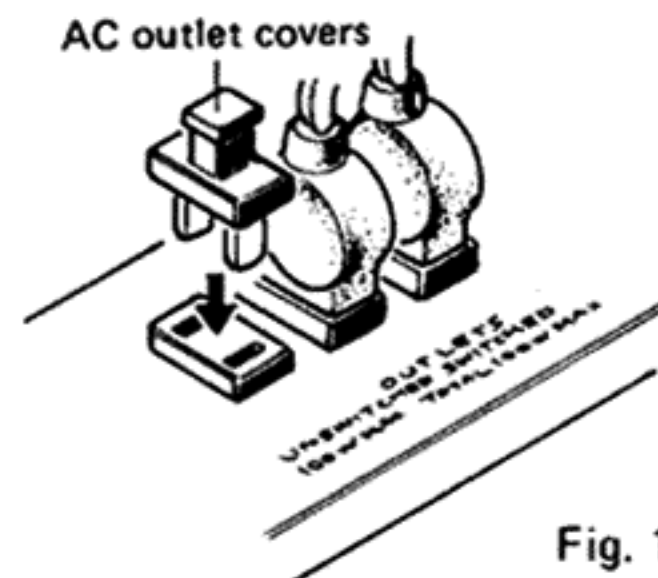

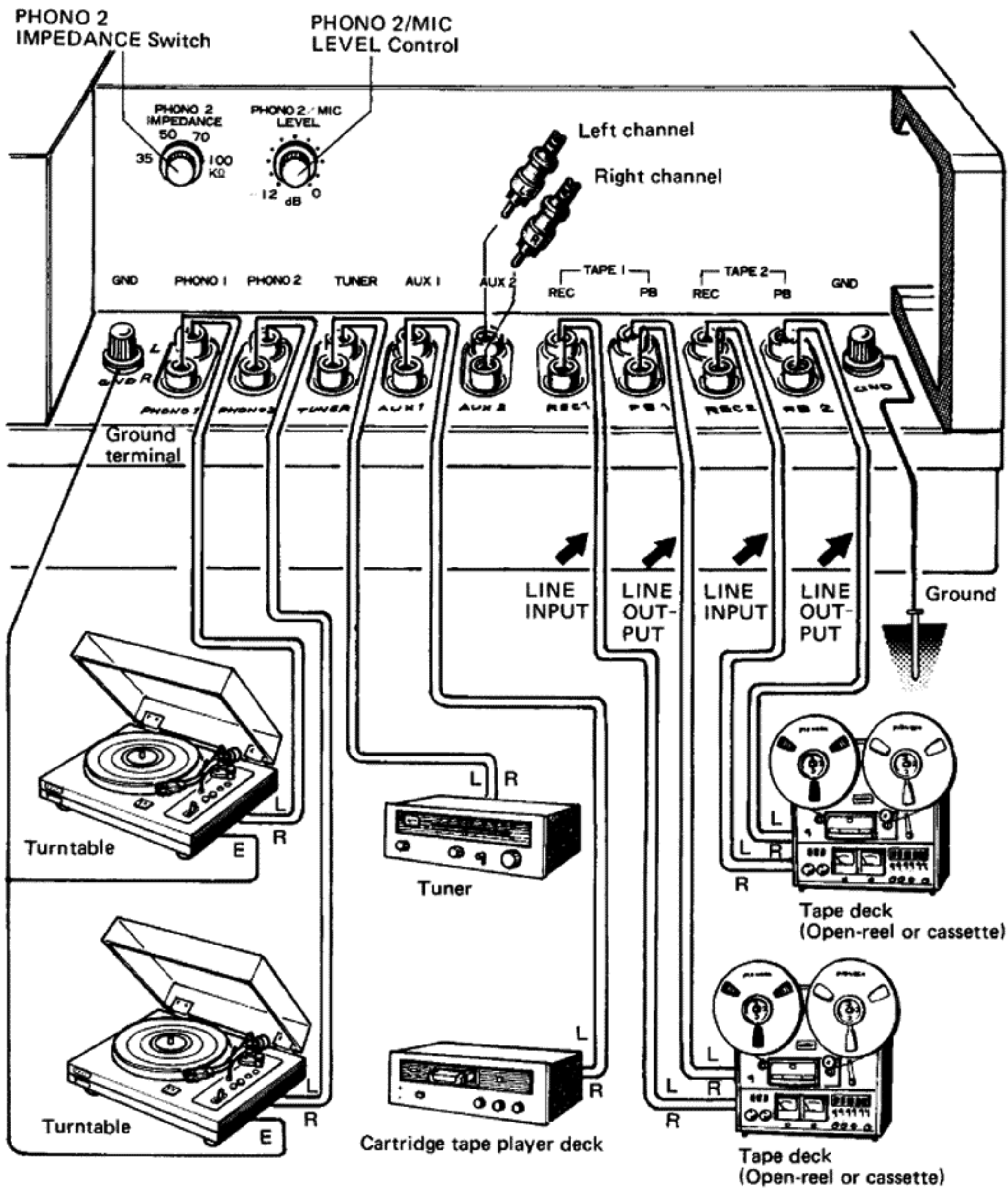

Get connecting cords through lead wire guide.

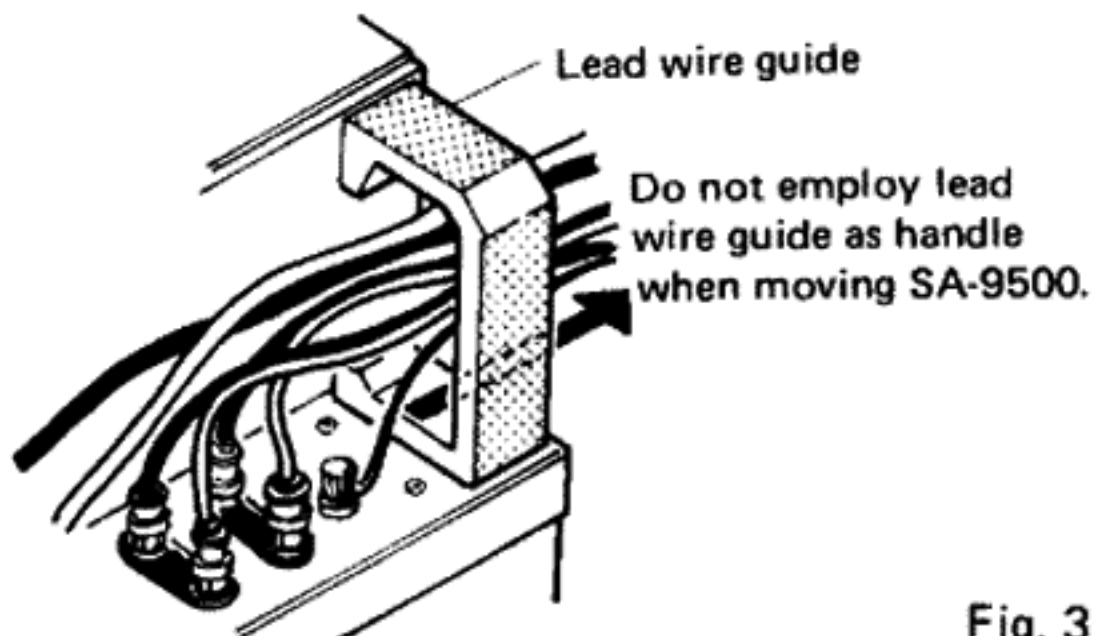

Fig. 3

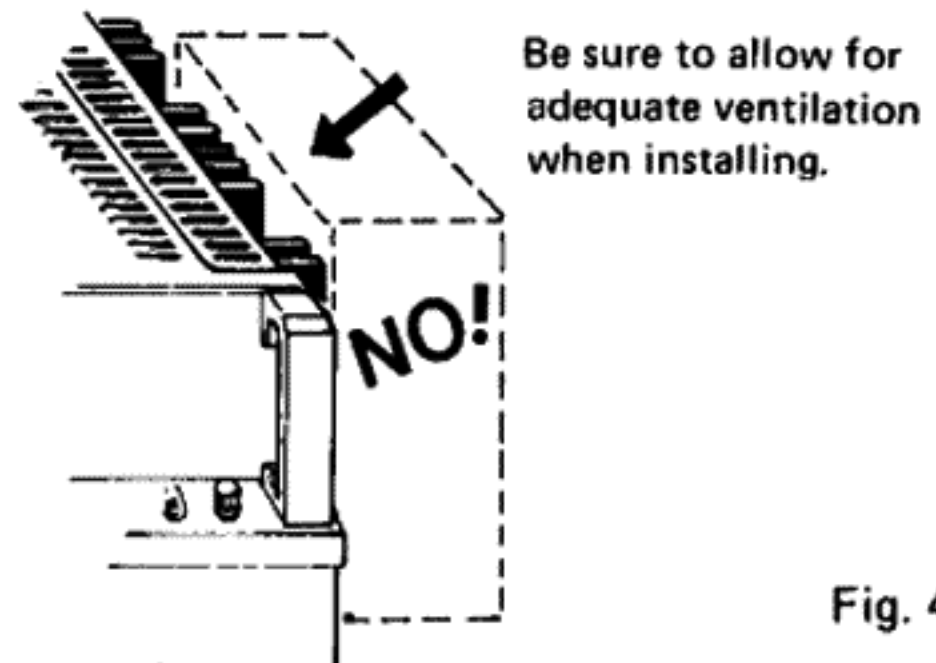

Fig. 4

CONNECTIONS

SPEAKER SYSTEM

The SA-9500 is provided with 2 sets of speaker output terminals, A and B. Normally, connect a pair of speaker systems to the A terminals.

- As shown in Fig. 5, connect the right channel (as viewed from the front) speaker to the R terminals, and the left channel speaker to the L terminals.
- Observe plus (+: red) and minus (-: black) polarities of the output terminals and those of the speakers. When performing connections, use care to connect + to + and - to - of the speakers and the SA-9500 speaker terminals.

NOTE:

If 2 sets of speaker systems (A & B) are to be simultaneously used, be sure that all speaker systems are 8Ω or more in impedance. Malfunction can be incurred if less than 8Ω speakers are employed.

Connecting Lead Wires to Speaker Terminals

1. Strip about 15mm (1/2") of the insulation from the end of lead wire.
2. If the conductor is stranded, twist the strands together to prevent spreading.
3. As shown in Fig. 6, depress the terminal button and insert the lead wire into the hole.
4. Release the button and confirm that the lead wire is secured in place.

TURNTABLE

Connect turntable outputs to the PHONO 1 jacks, and ground wire to the GND terminal.

NOTES:

1. A moving magnet (MM) type cartridge can be directly connected; however, a low output moving coil (MC) cartridge requires an accessory matching transformer or head amplifier.
 2. A second turntable can be connected to the PHONO 2 jacks.
 3. If the turntable is equipped with 2 tonearms, connect one tonearm to the PHONO 1 jacks and the other to the PHONO 2 jacks.
- The PHONO 2 jacks are provided with a LEVEL control for adjustment of the input level and an IMPEDANCE selector switch for switching of the input impedance (35, 50, 70, 100 k Ω). Operation of these features is described on p.12.

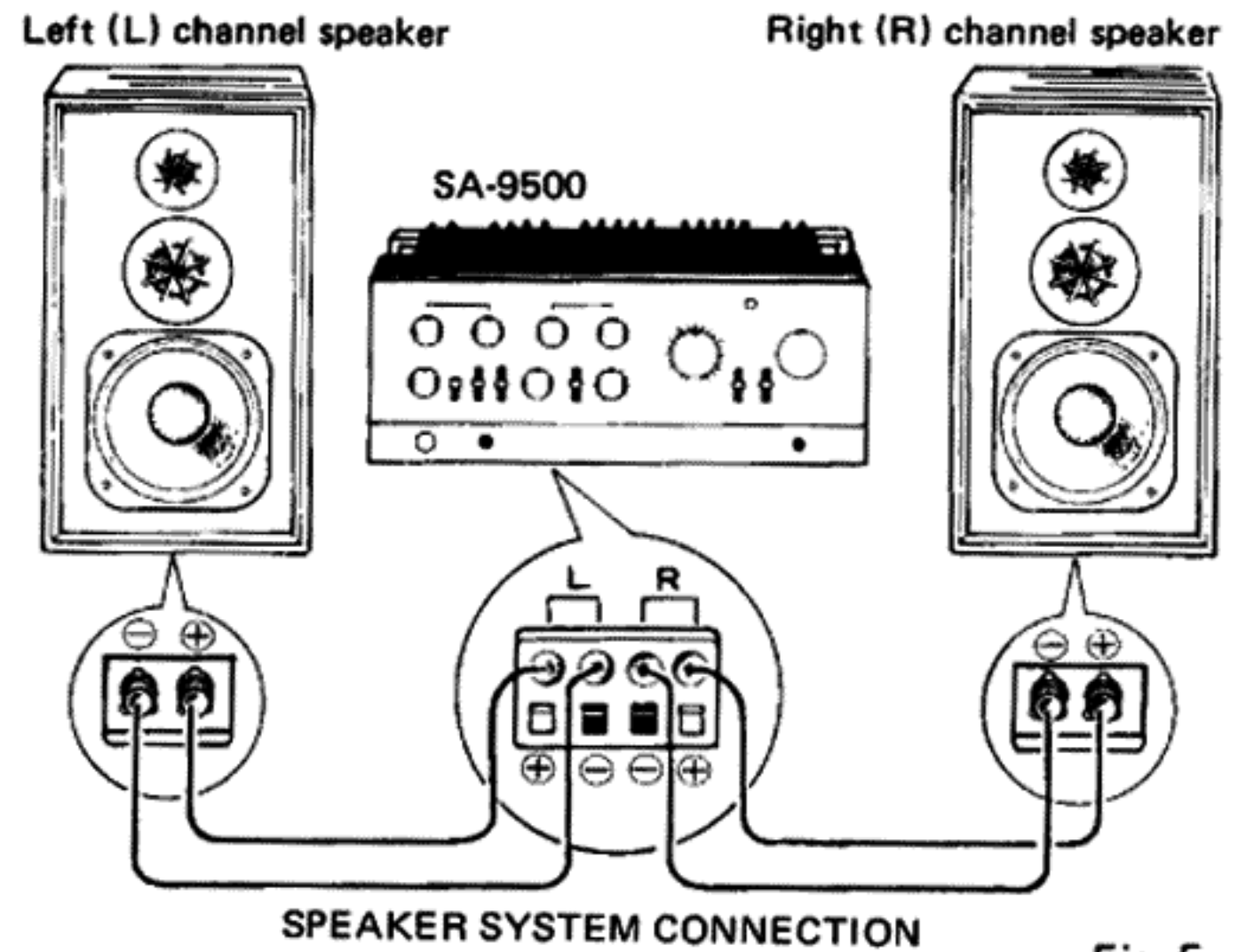

Fig. 5

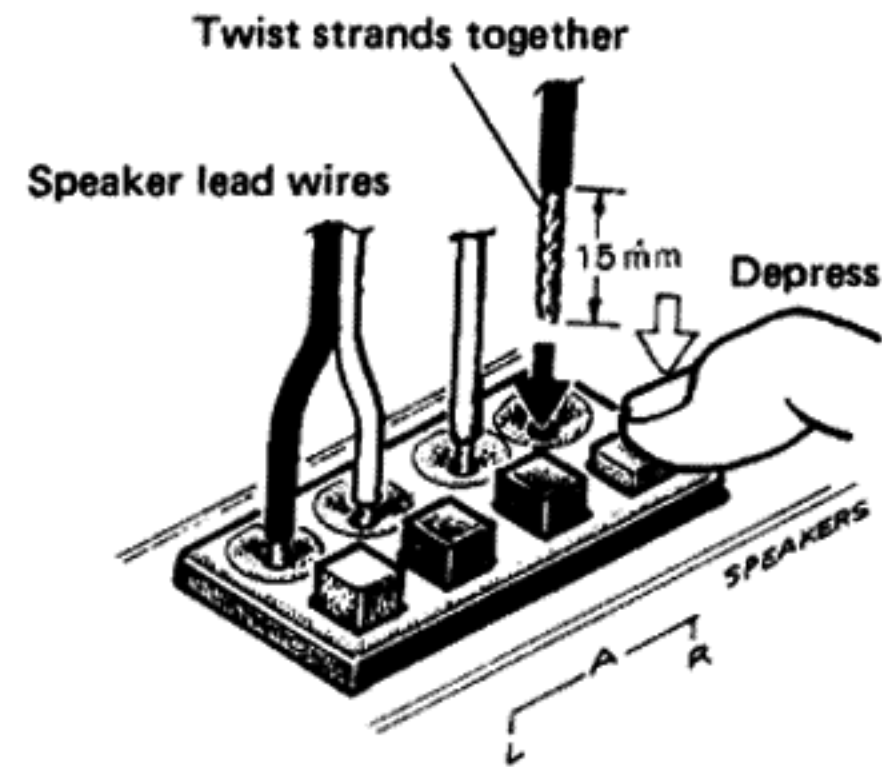

Fig. 6

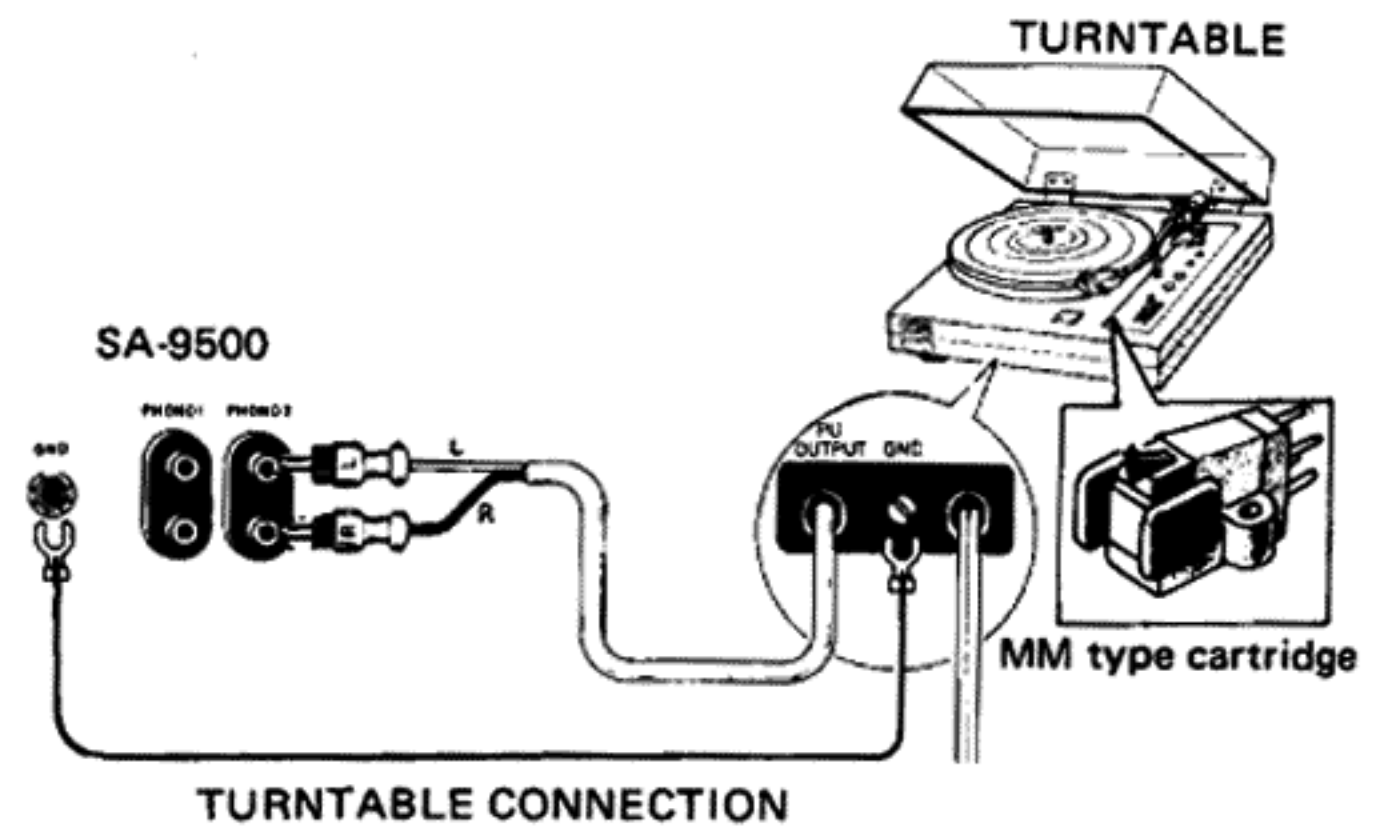

Fig. 7

TUNER

Connect an AM/FM stereo tuner to the TUNER jacks.

AUX 1 & 2 TERMINALS

These jacks are for auxiliary inputs. They can be used to connect a cartridge tape player deck, second tuner, or other source.

TAPE DECK (OPEN REEL OR CASSETTE)

The SA-9500 is provided with 2 sets of recording (TAPE 1 & 2 REC) and playback (TAPE 1 & 2 PB) jacks. Connect as follows:

Recording Connections

Connect the tape deck recording terminals (LINE INPUT) with the TAPE 1 REC jacks.

Playback Connections

Connect the tape deck playback terminals (LINE OUTPUT) with TAPE 1 PB jacks.

NOTES:

1. Connect a second tape deck to the TAPE 2 (REC & PB) jacks.
2. Employ connecting cords supplied with tape deck.

Using AC Outlets

These can be used to supply AC power to other components, such as tuner, turntable, tape deck, etc.

SWITCHED: AC power to component plugged into this outlet is coupled with the SA-9500 POWER switch setting. Maximum 100W total.

UNSWITCHED: AC power always present at this outlet, regardless of POWER switch setting. Maximum 100W.

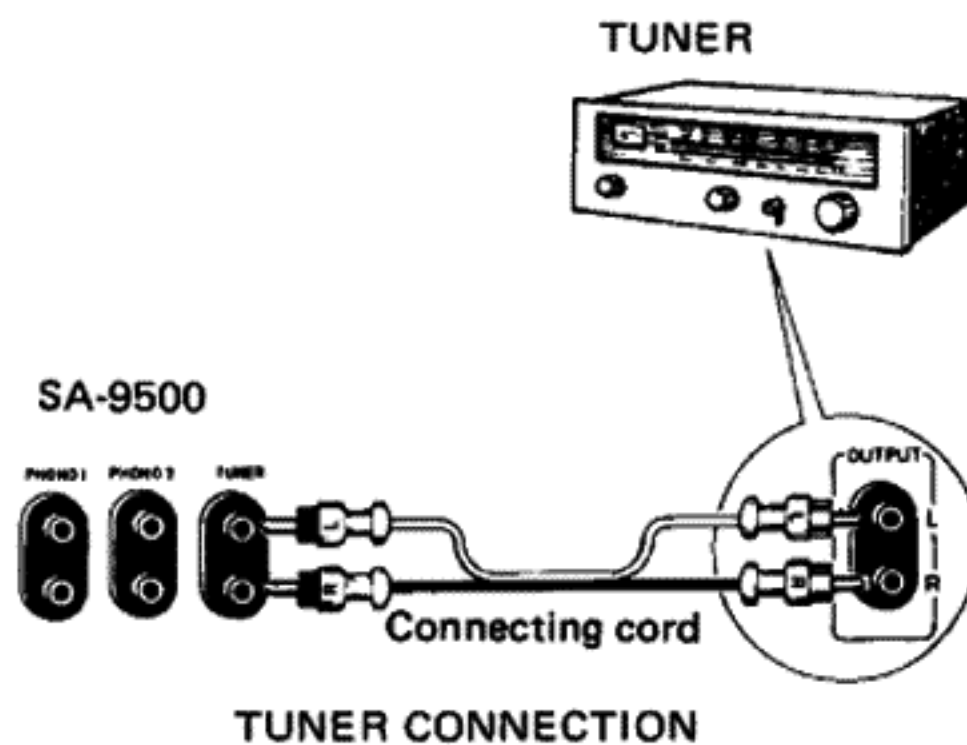

TUNER CONNECTION

Fig. 8

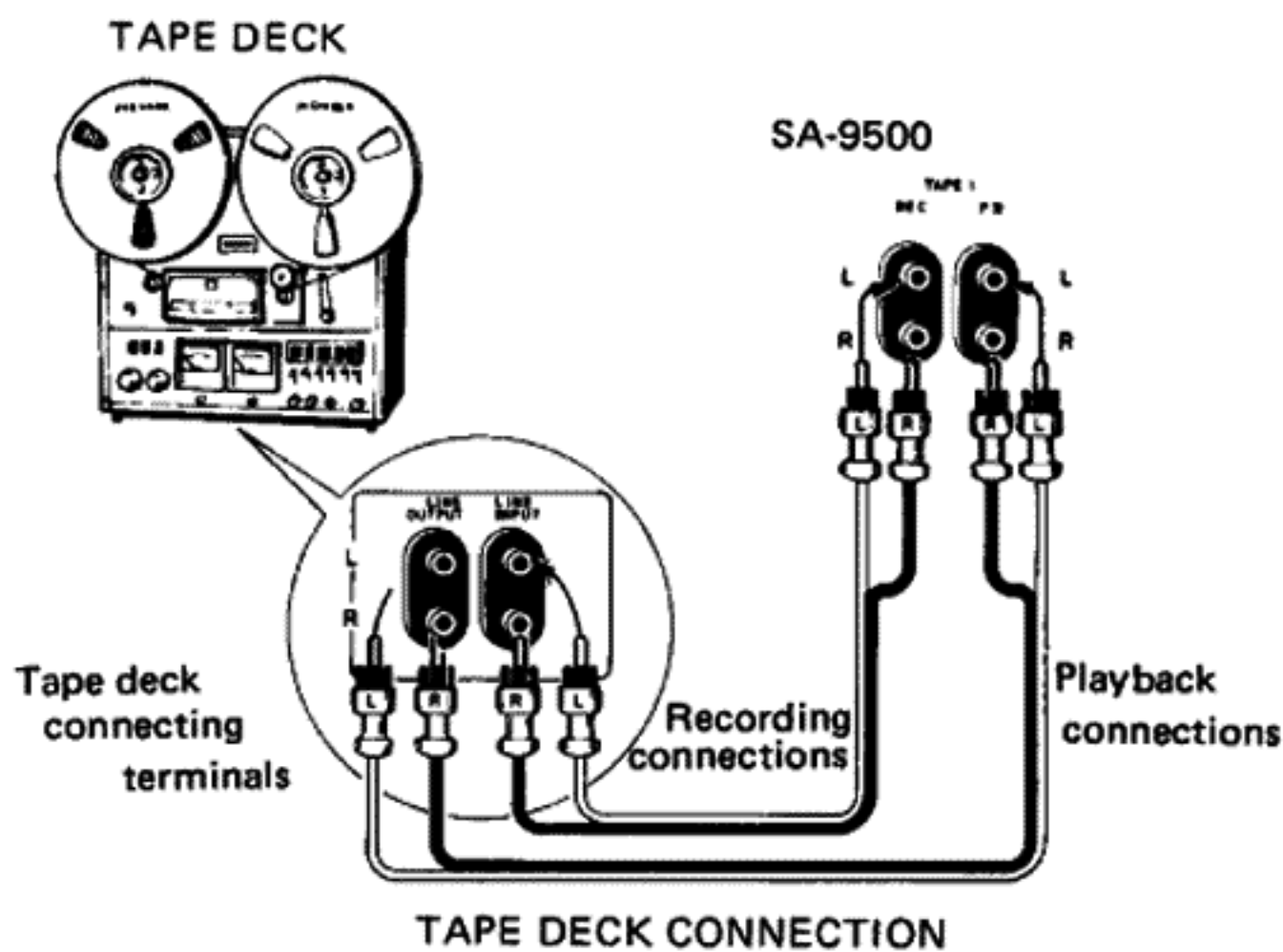

TAPE DECK CONNECTION

Fig. 9

FRONT PANEL FACILITIES

RESPONSE GRAPH

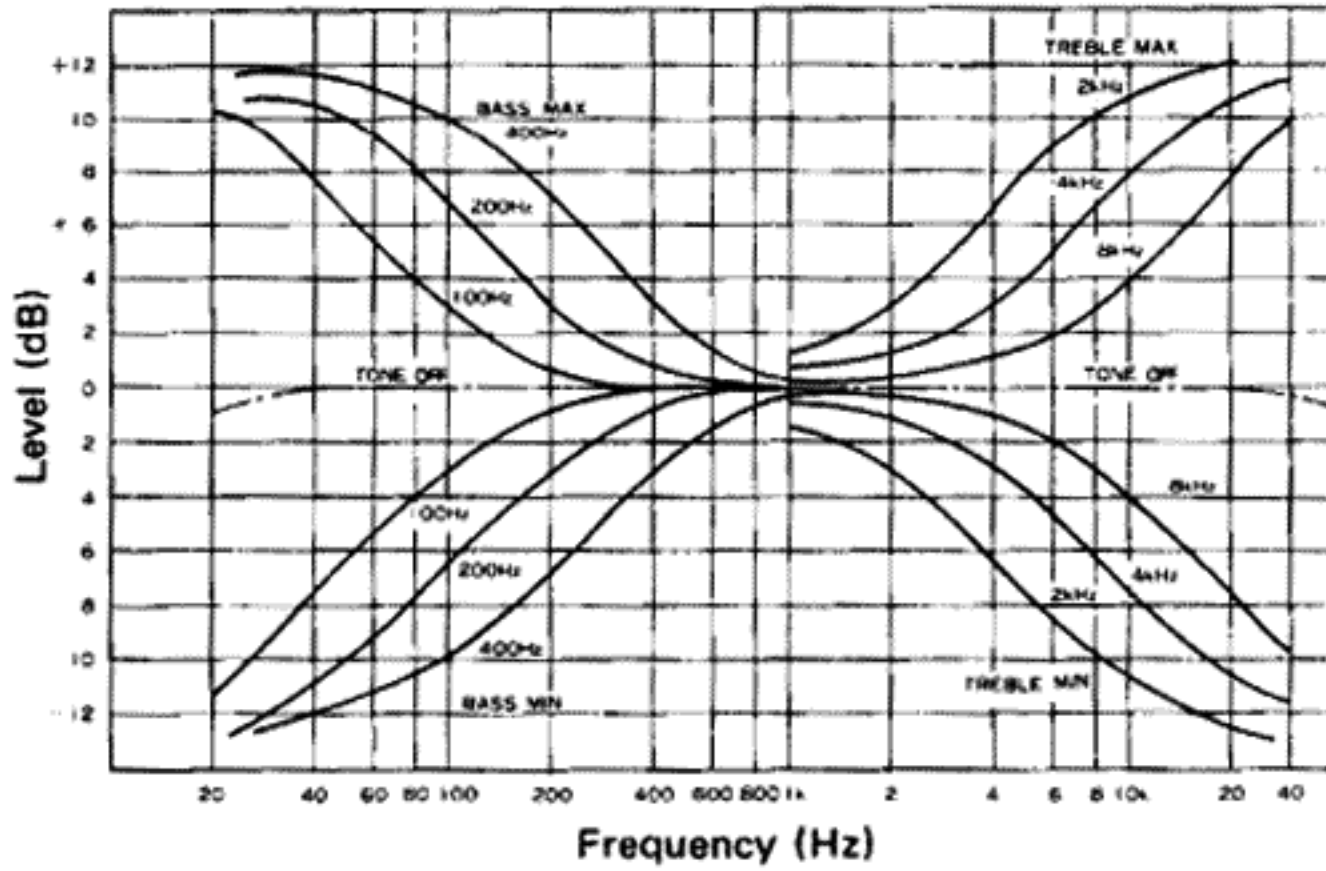

BASS TURN OVER SWITCH

As shown in the response graph, this switch selects the frequency at which the BASS control takes effect. Set the switch to 100Hz, 200Hz, or 400Hz according to listening room and speaker characteristics, or personal preference.

BASS CONTROL

Control for adjusting low frequency sound. When turned clockwise from center, frequencies below the value selected by the BASS TURN OVER switch are enhanced, while counter-clockwise rotation attenuates these frequencies. The control functions in 2dB steps.

SPEAKERS SWITCH

- OFF: Cuts off speaker sound (when using headphones only).
- A: Sound obtained from speakers connected to A speaker terminals.
- B: Sound obtained from speakers connected to B speaker terminals.
- A + B: Sound obtained from speakers connected to both A and B speaker terminals.

POWER SWITCH

Depress to turn on AC power. After the POWER switch is set to ON, a few seconds will elapse before sound is obtained. This is due to the built-in muting circuit and does not signify difficulty.

PHONES JACK

Output jack for stereo headphones.

TONE SWITCH

When set to OFF, the TONE control circuit is disengaged and frequency response becomes flat. The BASS and TREBLE twin controls do not function at this time. Convenient for checking phono cartridge and speaker tone, tone control effectiveness, and listening room acoustics.

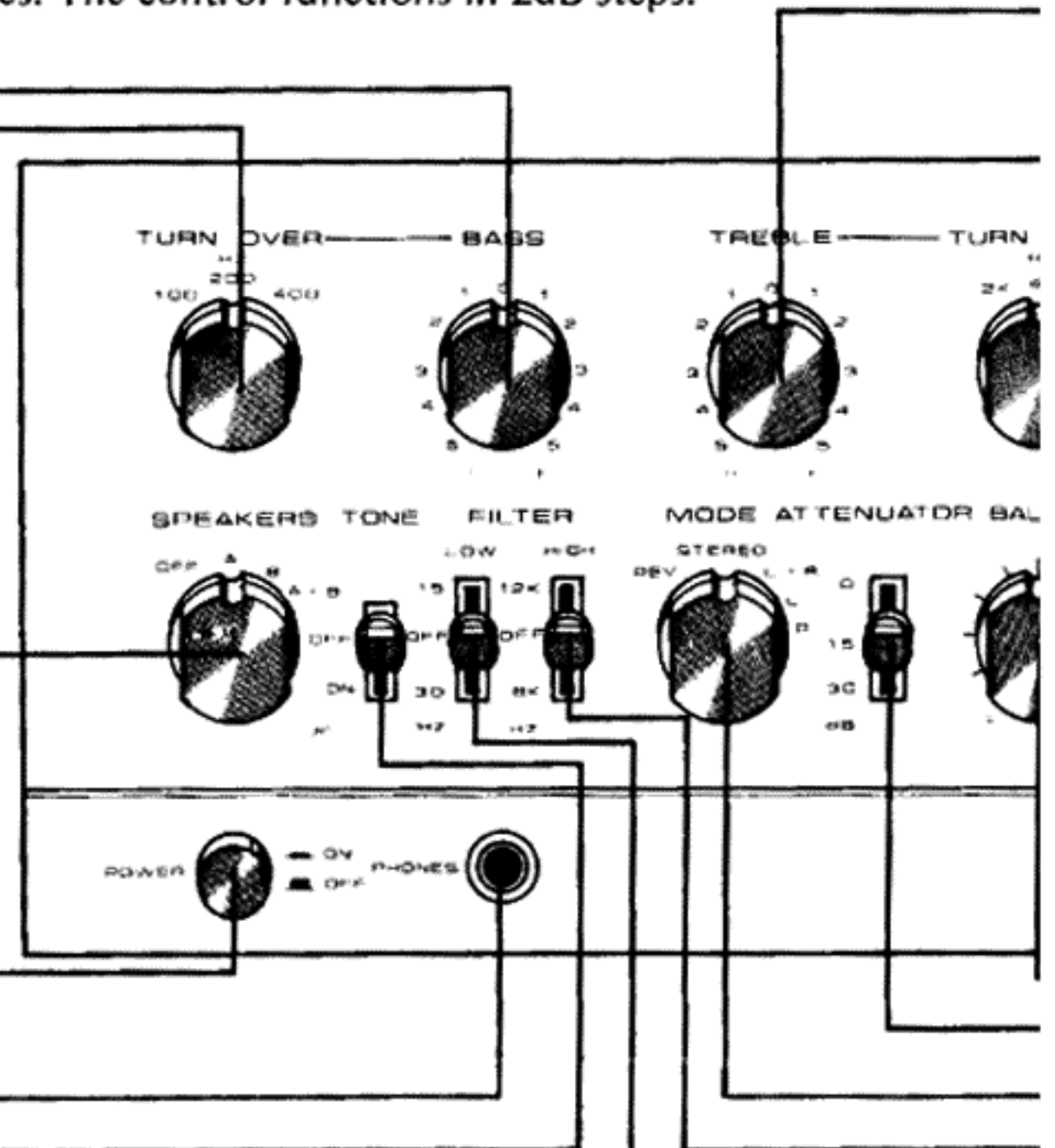

LOW FILTER SWITCH

- Attenuates low frequency noise.
- 15Hz: Provides 12dB/octave attenuation for frequencies below 15Hz.
- OFF: Set to this position when not employing filter.
- 30Hz: Provides 12dB/octave attenuation for frequencies below 30Hz.

HIGH FILTER SWITCH

- Attenuates high frequency noise, such as scratches and tape hiss.
- 12kHz: Provides 12dB/octave attenuation for frequencies above 12kHz.
- OFF: Set to this position when not employing filter.
- 8kHz: Provides 12dB/octave attenuation for frequencies above 8kHz.

TREBLE CONTROL

Control for adjusting high frequency sound. When turned clockwise from center, frequencies above the value selected by the TREBLE TURN OVER switch are enhanced, while counter-clockwise rotation attenuates these frequencies. The control functions in 2dB steps.

TREBLE TURN OVER SWITCH

As shown in the response graph, this switch selects the frequency at which the TREBLE control takes effect. Set the switch to 2kHz, 4kHz, or 8kHz according to listening room and speaker characteristics, or personal preference.

VOLUME CONTROL

Adjusts output level to speakers and headphones. Scale is graduated in dB with 0dB at maximum level. When employed in combination with the ATTENUATOR switch, finer and wider range attenuation can be performed. See additional description on p.12.

PILOT LAMP

Lights when AC power is turned on.

FUNCTION SWITCH

- PHONO 1: For playing records on a turntable connected to the PHONO 1 jacks.
- MIC/PHONO 2: Same as above, for PHONO 2 jacks, or for reproduction through a microphone connected to the MIC jack on the front panel. Note, when the microphone is connected to the jack, the turntable connected to the PHONO 2 jacks cannot be used.
- TUNER: For listening to broadcasts through the tuner.
- AUX 1: For playing signals fed to the AUX 1 jacks.
- AUX 2: Same as above, for AUX 2 jacks.

MIC JACK

Accepts the plug of the microphone.

TAPE MONITOR SWITCH

- 1: Playback or monitoring of tape deck connected to the TAPE 1 (REC & PB) jacks.
- SOURCE: Set to this position at times other than tape playback.
- 2: Playback or monitoring of tape deck connected to the TAPE 2 (REC & PB) jacks.

TAPE DUPLICATE SWITCH

Set to ON when employing 2 tape decks to duplicate or edit tapes. Be sure to set to OFF (upper position) at other times.

BALANCE CONTROL

Adjusts left and right volume balance of speakers and headphones. Turn clockwise from center to increase right channel (R) volume, and counterclockwise from center to increase left channel (L) volume.

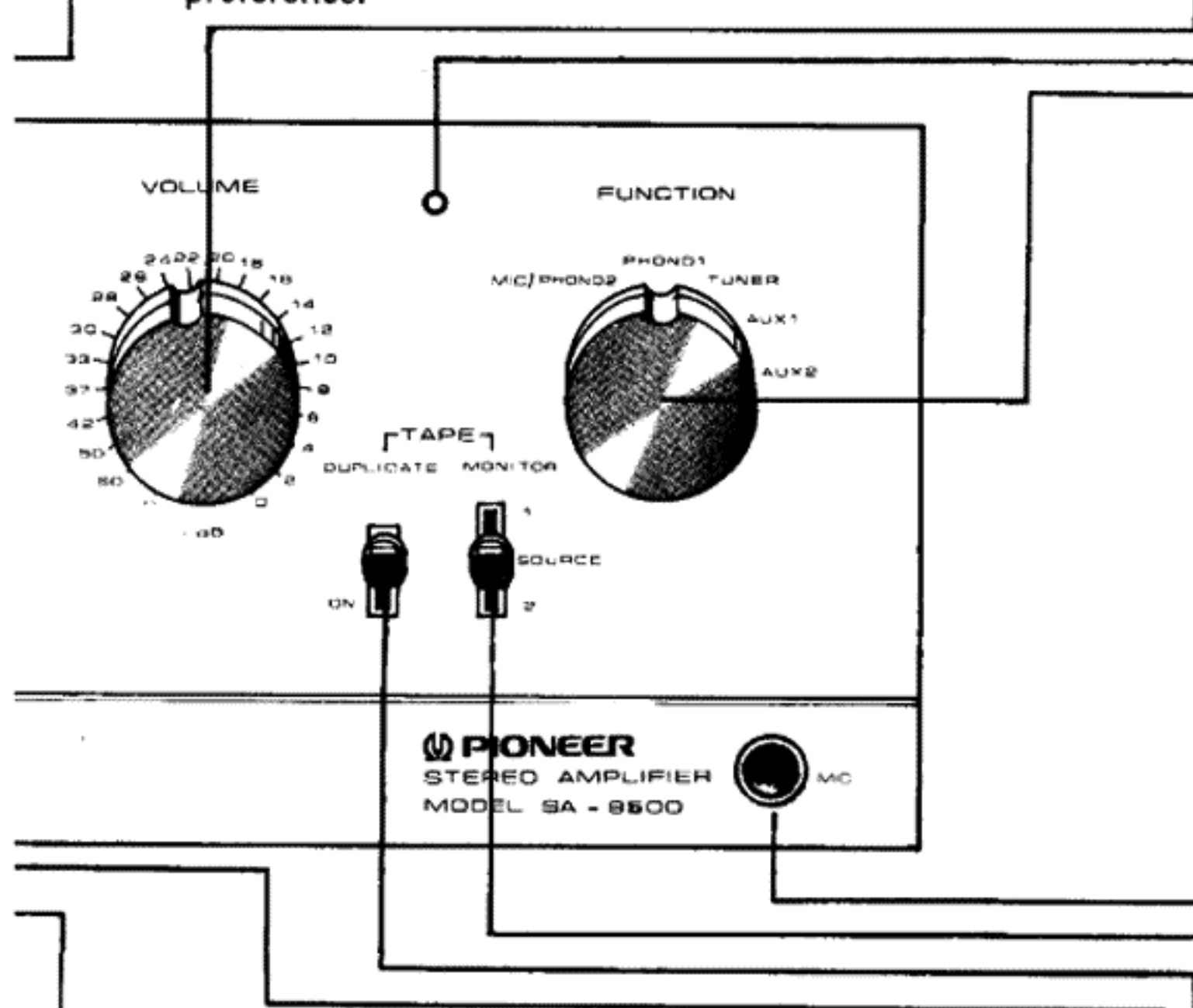

ATTENUATOR SWITCH

Attenuates the output level as follows:
 0dB: No attenuation
 -15dB: Attenuates by 15dB
 -30dB: Attenuates by 30dB

MODE SWITCH

- REV: Reverses left and right channel stereo signals.
- STEREO: Normal stereo reproduction.
- L + R: Mixes left and right channel signals for mono reproduction.
- L: Mono reproduction of left channel signal through both speakers.
- R: Mono reproduction of right channel signal through both speakers.

BEFORE OPERATION

Before setting the POWER switch to ON, set the other controls and switches as follows:

- VOLUME control to ∞ (minimum)
- ATTENUATOR switch to 0dB
- TAPE MONITOR switch to SOURCE
- TAPE DUPLICATE switch to upper position (OFF)
- MODE switch to STEREO
- TONE switch to OFF
- LOW & HIGH FILTER switches to OFF
- BASS & TREBLE controls to 0 (center position)
- SPEAKERS switch to A or B according to employed speaker terminals (A or B). Now you can switch your POWER switch ON.

OPERATION

PLAYING RECORDS

1. Set the FUNCTION switch to PHONO 1 if the turntable is connected to the PHONO 1 jacks, and to MIC/PHONO 2 if it is connected to the PHONO 2 jacks.

Note, however, that the turntable connected to the PHONO 2 jacks cannot be used if the microphone is plugged into the MIC jack.

2. Play record on turntable.
3. Adjust the VOLUME, BASS and TREBLE controls for desired volume and tone.

Notes

- Lower the tonearm gently onto the record. Temporarily setting the ATTENUATOR switch to -30dB will reduce noise incurred at this time.
- Do not turn off the power while the stylus is in contact with the record.
- Avoid imparting vibration to the turntable while a record is being played. This may cause the stylus to jump and possibly damage the record.
- Howling may be caused if the turntable is too close to the speaker systems. Allow for adequate spacing when installing.

NOTE:

The PHONO 2 jacks are provided with an input PHONO 2 / MIC LEVEL control and an IMPEDANCE switch. Their operation is described on p.12.

EMPLOYING TUNER (AM or FM Reception)

1. Set the FUNCTION switch to TUNER.
2. Tune in desired station on tuner.
3. Adjust VOLUME, BASS & TREBLE controls for desired volume and tone.

USING THE MICROPHONE

1. Connect the microphone to the MIC jack.
2. Set the FUNCTION switch to MIC/PHONO 2
3. Adjust the sound level by turning the VOLUME control to the right little by little.

NOTES:

- You should use a high impedance (above 20k Ω) dynamic type microphone with a standard 6mm diameter phone plug. Pioneer puts on the market a wide variety of high performance microphone for you selection.
- Under certain conditions of use, a microphone gives rise to howling or feedback noise. Take care not to raise the volume too high when the microphone is close to the speaker system or in a room with a great deal of resonance. Microphone will perform most effectively with TREBLE and BASS controls at their midway positions.
- While using the microphone, only microphone sound will be heard through the left and right speakers.

EMPLOYING AUX COMPONENTS

Auxiliary components, such as a cartridge tape player deck, can be connected to the AUX 1 & 2 jacks.

1. Set the FUNCTION switch to AUX 1 to play a component connected to the AUX 1 jacks, and to AUX 2 to play a component connected to the AUX 2 jacks.
2. Operate component.
3. Adjust VOLUME, BASS & TREBLE controls for desired volume and tone.

Protection Circuit

- After turning on the power of the SA-9500, 6 ~ 8 seconds will elapse before sound is obtained from the speakers. This is due to the operation of the built-in protection and muting circuit. It serves to both prevent switching noise when the power is turned on and off, and protect the speakers in event DC occurs in the output.
- Operation of the internal relay during playing will cause continuous a clicking noise. This would most likely be caused by speaker terminal shorting or overload (used speaker impedance less than 4 Ω). The protection circuit functions automatically in this type of case to disconnect the speaker terminals and safeguard the transistors and speakers. The circuit is self-resetting and after the cause of trouble has been corrected, it will return to normal condition.

EMPLOYING TAPE DECK

TAPE PLAYBACK

1. Set the TAPE MONITOR switch to 1 if the tape deck is connected to the TAPE 1 jacks, and to 2 if it is connected to the TAPE 2 jacks.
2. Play tape on tape deck.
3. Adjust VOLUME, BASS & TREBLE controls for desired volume and tone.

NOTES:

1. Be sure to set the TAPE MONITOR switch to SOURCE when not playing tape.
2. FUNCTION switch setting is irrelevant when playing tape.

TAPE RECORDING

1. Set FUNCTION switch to the source to be recorded (PHONO, TUNER, etc.).
2. Operate program source.
3. Adjust recording levels with the controls of the tape deck and proceed with recording.

NOTE:

Set DUPLICATE switch to OFF during recording.

Monitoring Recording Conditions

If the tape deck is a 3-head type recording conditions can be monitored through the speakers by setting the TAPE MONITOR switch to 1 (or 2). Both recording and playback connections must be performed in this case.

TAPE DUPLICATION & EDITING

By employing 2 tape decks, the desired material only from a previously recorded tape can be edited onto a second tape. A personal tape library can be compiled in this manner.

1. Connect 2 tape decks as shown Fig.12.
 2. Set the TAPE DUPLICATE switch to ON.
 3. On one tape deck (1 or 2) playback the pre-recorded tape, and perform recording with the other deck.
- Duplication is performed while monitoring the recording. Set the TAPE MONITOR switch to 1 (or 2) according to the deck being used for recording 1 (or 2).

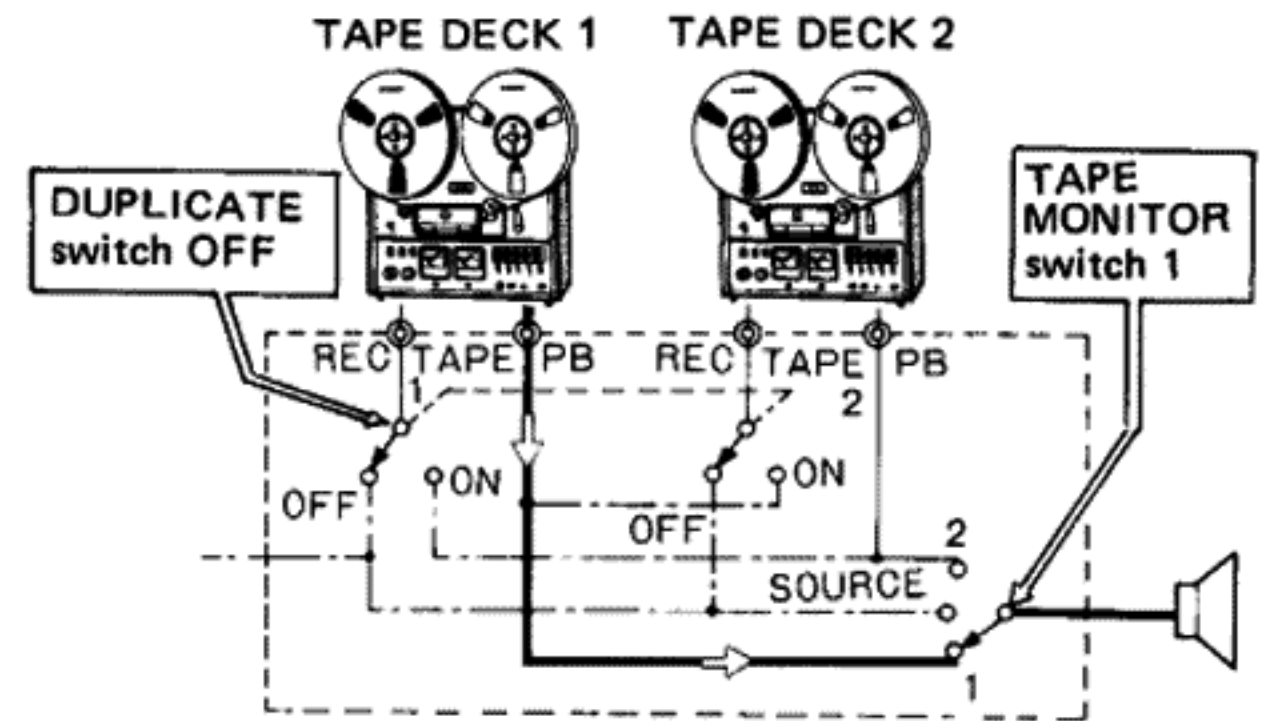

Tape playback: Playback signal enters TAPE 1 (or 2) PB jacks, passes through TAPE MONITOR switch 1 (or 2) and is heard from the speakers.

Fig. 10

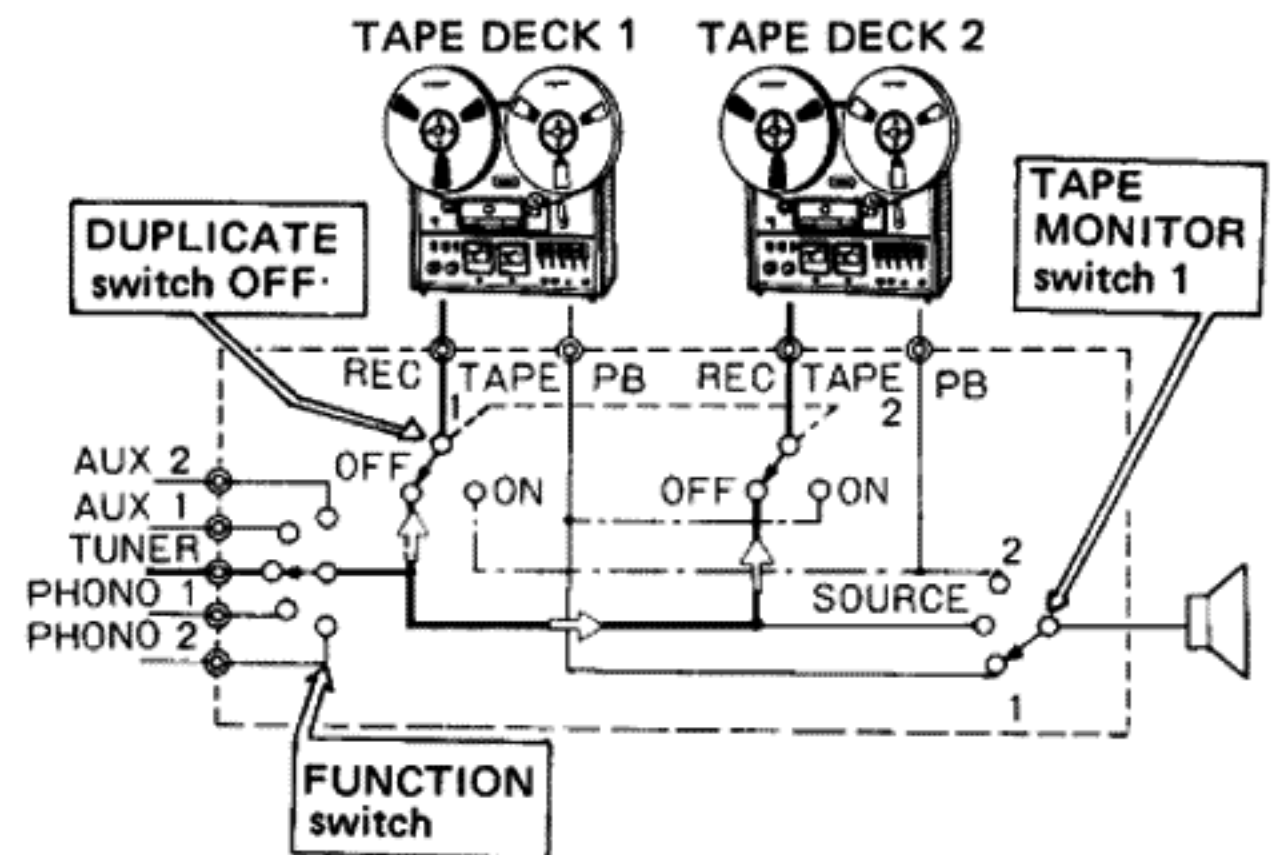

Tape recording: The input signal selected by the FUNCTION switch is always present at a fixed level at the TAPE 1 & 2 REC jacks. Monitoring can be performed at this time by setting the TAPE MONITOR switch to 1 or 2, according to the TAPE jacks being used for recording.

Fig. 11

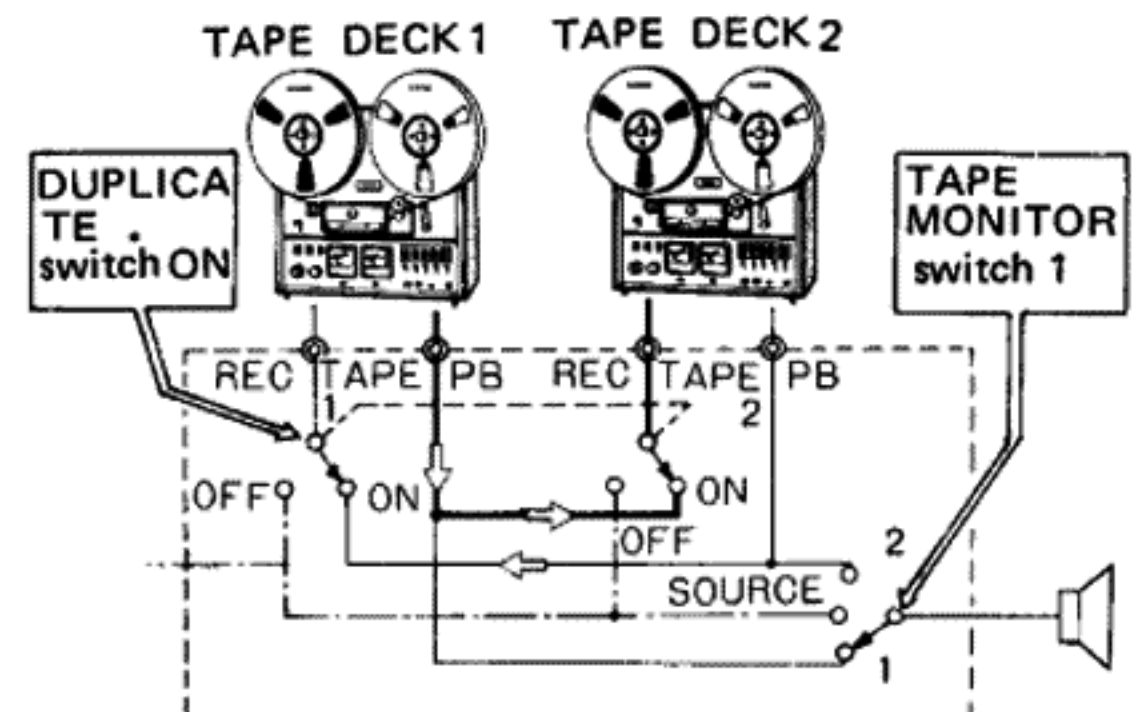

Duplication: Playback signal from tape deck 1 in the figure enters via TAPE 1 PB jacks, passes through DUPLICATE switch ON, and is recorded by tape deck 2. This can also be performed in reverse, ie: playback with tape deck 2 and record with tape deck 1.

Fig. 12

EFFECTIVE OPERATION

USING THE PHONO 2/MIC LEVEL CONTROL

- The LEVEL control adjusts the input level (sensitivity) of the PHONO 2 jacks in the range from 2.5 to 10mV and the MIC jack in the range from 6mV to 24mV. For example, if a high output voltage cartridge is connected to the PHONO 2 jacks, the control can be used to match its level with that of the cartridge connected to the PHONO 1 jacks.

USING THE PHONO 2 IMPEDANCE SWITCH

- Set the IMPEDANCE switch to 35, 50, 70, or 100k Ω according to the specified load resistance of the employed cartridge. Even with a 50k Ω cartridge, the frequency response can be changed as shown in Fig. 19 to provide the desired tone.

VOLUME CONTROL & ATTENUATOR SWITCH

- By combining the direct reading dB VOLUME control and ATTENUATOR switch, 56 varieties of volumes (attenuations) can be accurately obtained as shown in the table below. The attenuation amount becomes the sum of both settings.
- The ATTENUATOR switch can be used to briefly lower the volume when changing records or tapes.

Attenuation amounts obtainable by combining the VOLUME control and ATTENUATOR switch.

0, 2, 4, 6, 8, 10, 12, 14, 15, 16, 17
18, 19, 20, 21, 22, 23, 24, 25, 26, 27, 28
29, 30, 31, 32, 33, 34, 35, 36, 37, 38, 39
40, 41, 42, 43, 44, 45, 46, 48, 50, 52, 54
56, 57, 58, 60, 63, 65, 67, 72, 75, 80, 90
∞

in-dB

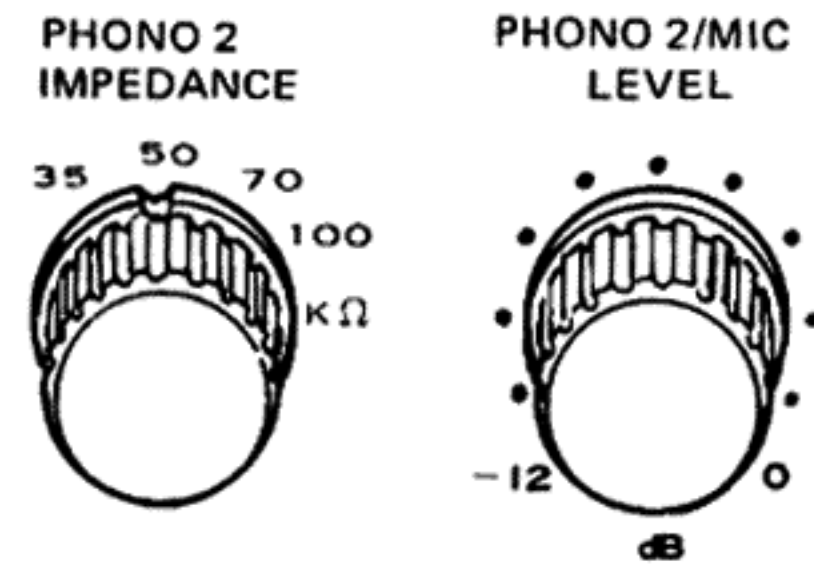

IMPEDANCE switch and LEVEL control of PHONO 2 jacks.

Fig. 18

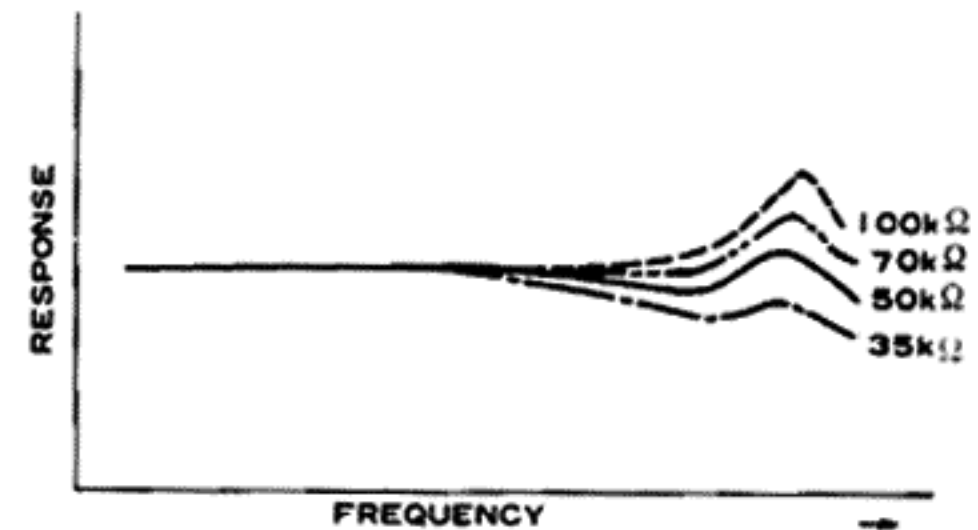

Cartridge frequency response graph according to impedance setting.

Fig. 19

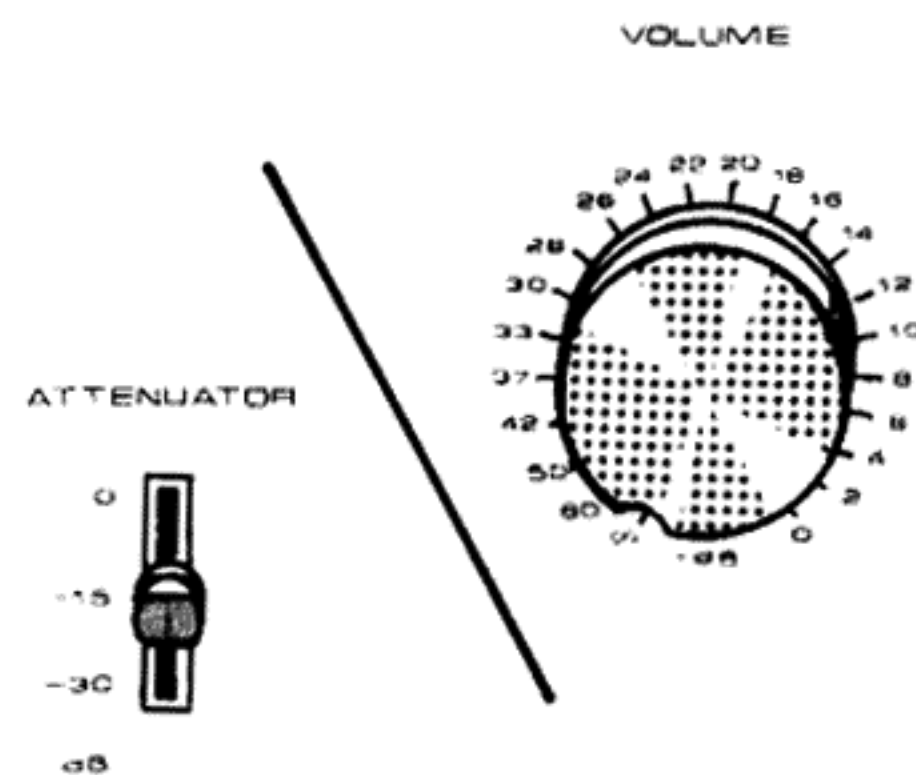

ATTENUATOR switch and VOLUME control.

Fig. 20

EMPLOYING PRE OUT & POWER IN JACKS

USING PREAMP & POWER AMP SECTIONS INDEPENDENTLY

Setting the PRE/POWER AMP switch to SEPARATED allows the preamp and power amp sections to be employed independently. For example, using only the preamp section of the SA-9500, another external power amplifier can be employed. By switching between the external and SA-9500 self-contained power amplifiers, comparison listening can be performed.

Multi-amplifier System Composition

With the PRE/POWER AMP switch set to SEPARATED, a separately sold electronic crossover network and one or more power amplifiers can be combined to form a multi-amp system. The audio frequency band is then divided into segments, with each range amplified by its own power amplifier. Improvements can be noted in such factors as intermodulation distortion, etc.

Composing 2 way Multi-amplifier System.

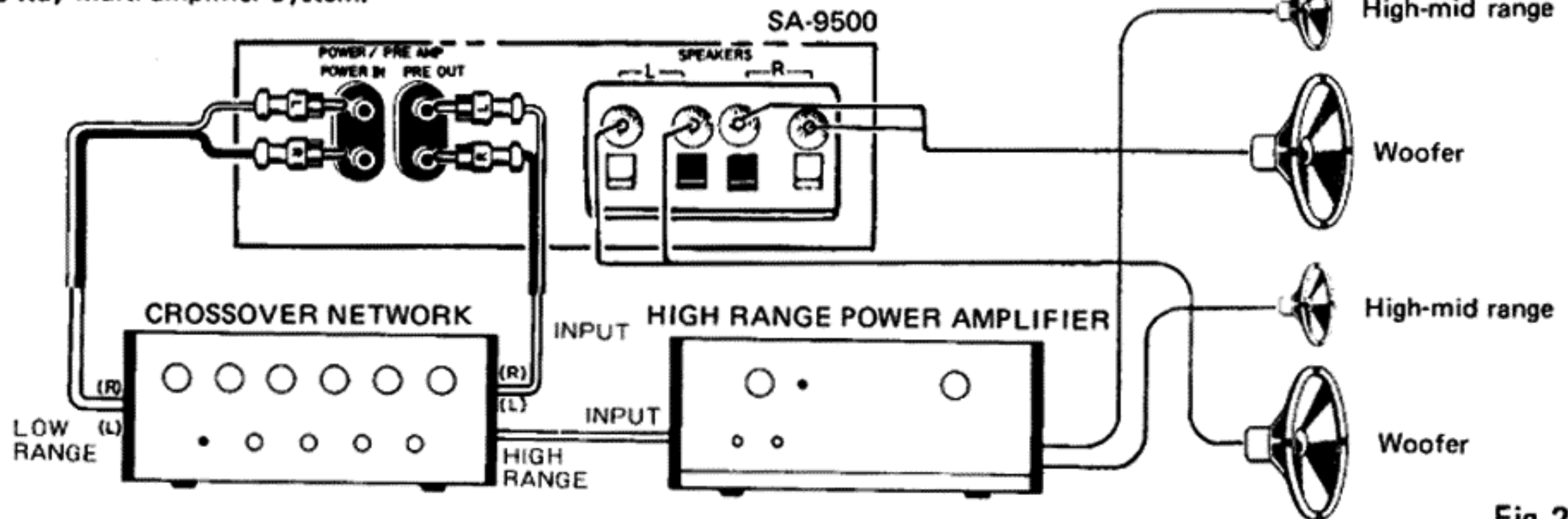

Fig. 22

Employing Auxiliary Power Amplifier

By setting the PRE/POWER AMP switch to NORMAL, a separately sold power amplifier can be connected as shown in the figure. This arrangement is suitable in situations such as a large auditorium where the SA-9500 built-in power amplifier alone would be insufficient.

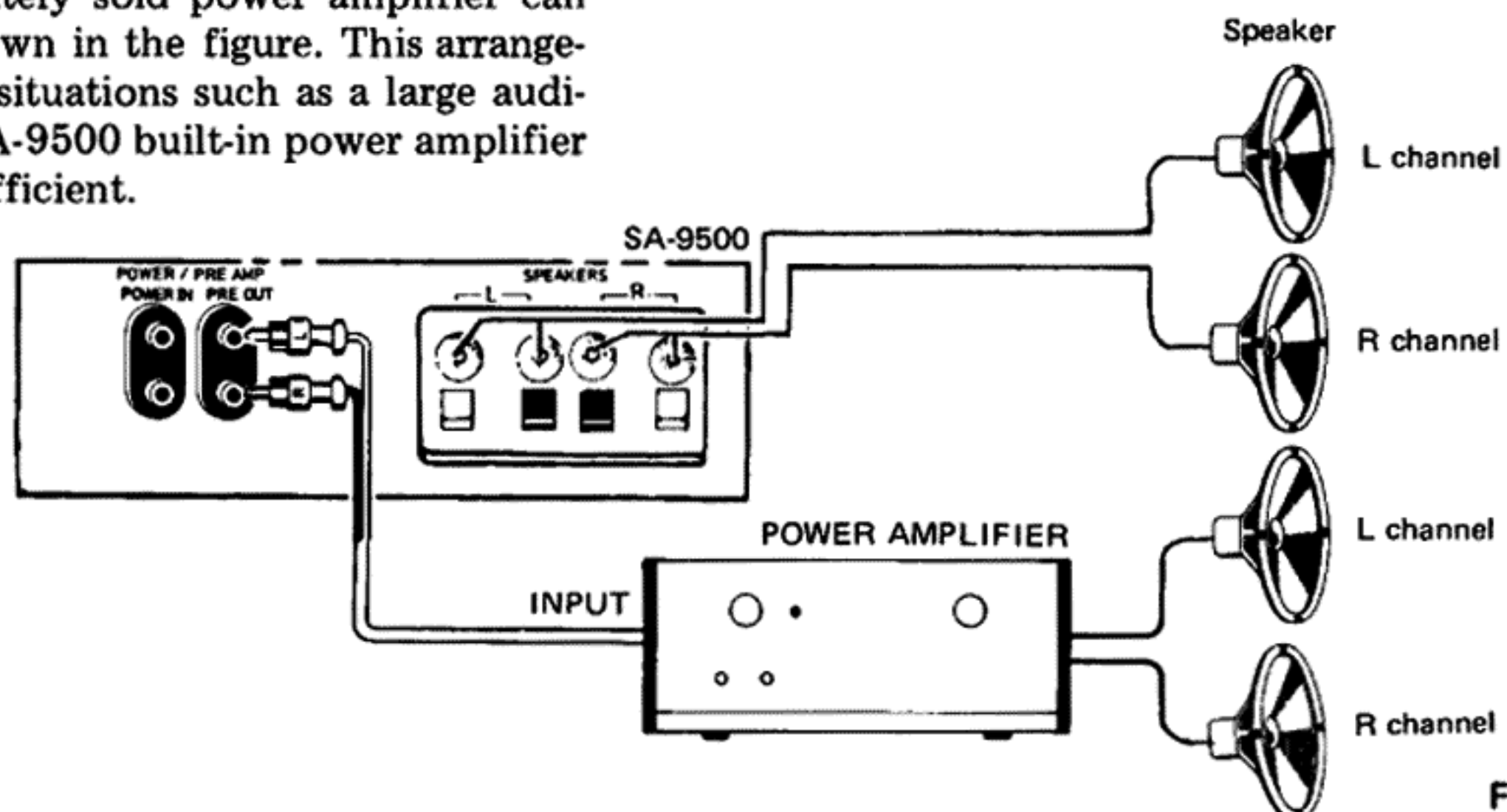

Fig. 23

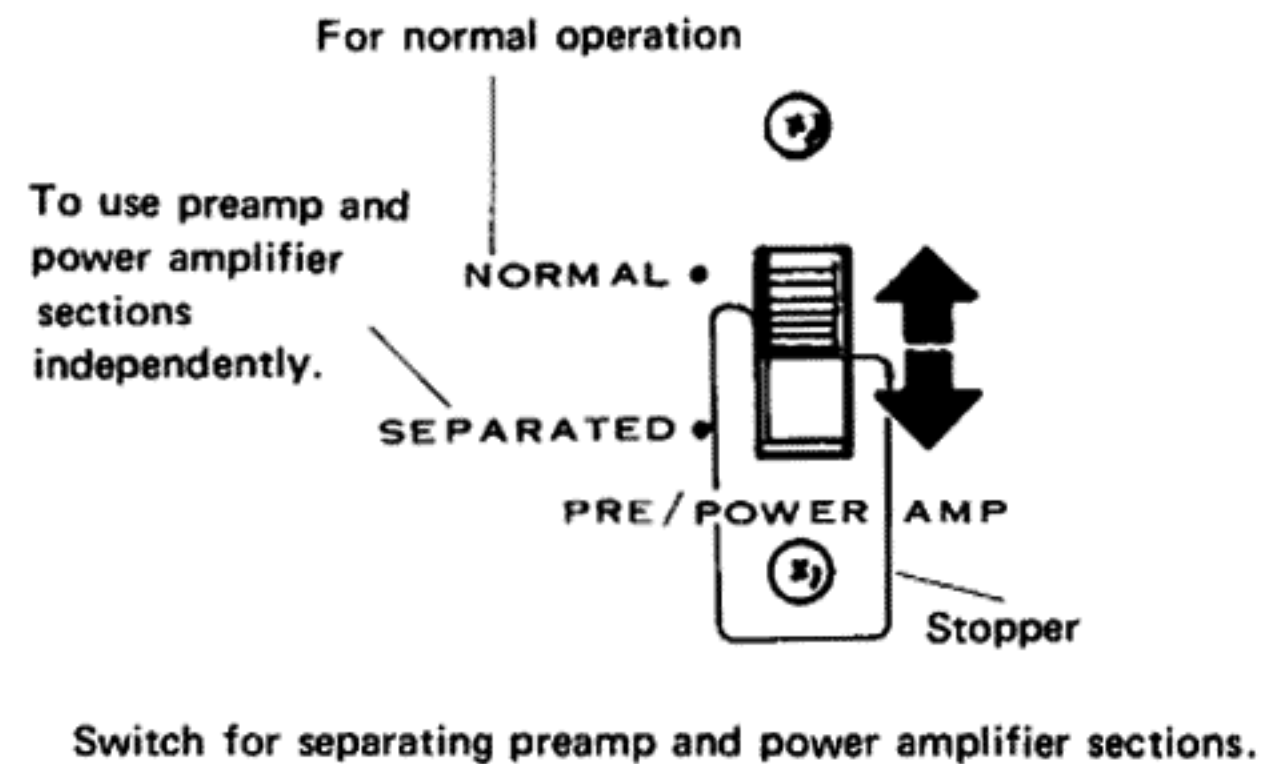

Fig. 21

SPECIFICATIONS

Semiconductors

FET(s)	2
Transistors	54
Diodes	26

Power Amplifier Section

Circuitry 1st stage differential amplifiers. Direct Coupled parallel push-pull, pure-complementary OCL.

80 watts* per channel, min. RMS, at 8 ohms, or 100 watts* per channel, 4 ohms from 20 Hertz to 20,000 Hertz with no more than 0.1% total harmonic distortion.

Continuous Power Output at 1,000 Hertz
(Both channels driven) 85 watts per channel (8 ohms)
110 watts per channel (4 ohms)

Total Harmonic Distortion at 20 Hertz to 20,000 Hertz
(Continuous Rated Power Output) No more than 0.1%
(40 watts per channel Power Output, 8 ohms) No more than 0.05%
(1 watt per channel Power Output, 8 ohms) No more than 0.05%

Intermodulation Distortion at 20 Hertz to 20,000 Hertz
(Continuous Rated Power Output) No more than 0.1%
(40 watts per channel Power Output, 8 ohms) No more than 0.05%
(1 watt per channel Power Output, 8 ohms) No more than 0.05%

Frequency Response 10 Hertz to 80,000 Hertz ± 1 dB

Input: Sensitivity/Impedance
(POWER AMP IN) 1V/50 k ohms

Output: Speaker A, B, A+B
Headphone Low Impedance

Damping Factor (20 Hertz to 20,000 Hertz, 8 ohms) 30

Hum & Noise (IHF, Short-circuited, A Network) 100dB

Preamplifier Section

Circuitry

Equalizer amplifier 3-stage direct-coupled class-A SEPP type with 1st stage differential amplifier.

Control amplifier 2-stage direct-coupled with one FET, NF type.

Input: Sensitivity/Impedance

PHONO 1 2.5mV/50 k ohms

PHONO 2 2.5mV to 10mV/35 k ohms,
50 k ohms, 70 k ohm, 100 k ohms

MIC 6mV to 24mV/85 k ohms

TUNER 150mV/50 k ohms

AUX 1 150mV/50 k ohms

AUX 2 150mV/50 k ohms

TAPE PB 1 150mV/50 k ohms

TAPE PB 2 150mV/50 k ohms

PHONO Overload Level (T.H.D. 0.01%)

PHONO 1 250mV (1,000 Hertz)

PHONO 2 250mV to 500mV (1,000 Hertz)

Output: Level/Impedance

TAPE REC 1 150mV

TAPE REC 2 150mV

PRE OUT 2V/1 k ohms

Total Harmonic Distortion at 20 Hertz to 20,000 Hertz

. No more than 0.05%

Frequency Response

PHONO (RIAA equalization) 30 Hertz to 15,000 Hertz ± 0.2 dB

TUNER, AUX, TAPE PB 7 Hertz to 40,000 Hertz ± 1 dB

Tone Control (2dB step)

BASS ± 10 dB (25 Hertz/50 Hertz/100 Hertz)
(Turnover Frequency) 100 Hertz/200 Hertz/400 Hertz

TREBLE ± 10 dB (8,000 Hertz/16,000 Hertz/32,000 Hertz)
(Turnover Frequency) 2,000 Hertz/4,000 Hertz/8,000 Hertz

Filter

LOW 15 Hertz, 30 Hertz (12dB/oct.)

HIGH 8,000 Hertz, 12,000 Hertz (12dB/oct.)

Hum & Noise (IHF, Short circuited, A Network)

PHONO 1 & 2 More than 70dB

MIC More than 65dB

TUNER, AUX 1 & 2, TAPE PB 1 & 2 More than 90dB

Attenuator 0, -15dB, -30dB

Micellaneous

Power Requirements AC 120V, 60 Hertz

Power Consumption 370W

AC Outlets 2 (Switched), 1 (Unswitched)

Dimensions 420 (W) x 165 (H) x 403 (D) mm
16-1/2 x 6-1/2 x 15-7/8 in.

Weight: Without Package 17.2kg (37lb13oz)

With Package 20kg (44lb)

Furnished Parts

Hex. Wrench (used for fastening VOLUME knob) 1

Jack covers 22

AC outlet covers 3

Connection Cord with Pin Plugs 1

Factory Tested Data 1

Operating Instructions 1

*Measured pursuant to Federal Trade Commission's Trade Regulation rule on Power Output Claims for Amplifiers.

NOTE:

Specifications and the design subject to possible modification without notice due to improvements.

CONDITIONS FREQUENTLY MISTAKEN FOR MALFUNCTION

If you think that there is a defect, please check the following steps.

If this does not help, please inform your Pioneer Authorized Service Center about product name and symptoms.

1. No sound
 - No power (pilot lamp not lit)
Is the power switch on? — Is the power cord plugged in? — Is the wall receptacle live?
 - Nothing can be heard
PRE/POWER AMP switch position? — SPEAKER switch? — TAPE MONITOR DUPLICATE switch? — VOLUME knob, ATTENUATOR?
 - Records can not be heard
Does the FUNCTION switch position correspond with the — Turntable connection?
PHONO terminals?
 - Radio (FM, AM) can not be heard
FUNCTION switch position? — Tuner connection? — Error in the tuner operation?
 - Tape playback can not be heard
Do tape deck connection terminals and — Is the tape prerecorded? — Tape deck connection — Error in the playback operation?
TAPE MONITOR switch operation connection?
2. Much noise
 - Appearing when listening to records
Are there scratches or dust on the record? — Is the earth wire connected? — Is there influence from other equipment (amateur radio, neon lights, etc.)?
 - Appearing with playback of tape
Is the noise recorded on the tape? — Is the earth wire connected? — Check the tape deck.
3. Much distortion
 - Appearing when listening to records
Is there dust or dirt on the stylus? — Is the stylus worn? — Is the stylus pressure correct? — Is there howling because of vibrations transmitted to the turntable?
 - Appearing with playback of tape
Is the output level of the deck correct? — Is the distortion recorded on the tape? — Check the tape deck

