

YAMAHA PG1

GUITAR AND INSTRUMENT PREAMPLIFIER

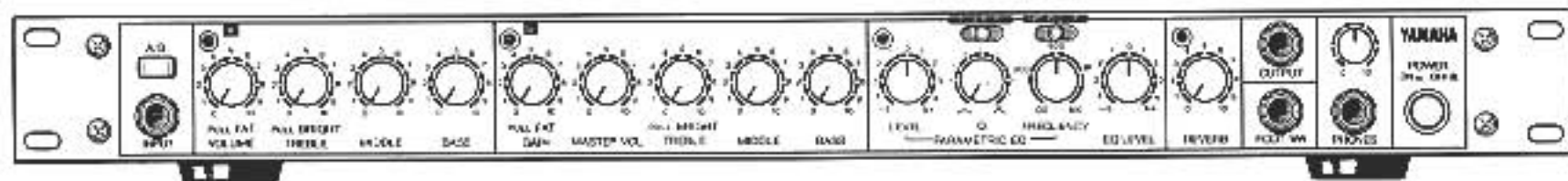

OWNER'S MANUAL

INTRODUCTION

Thank you for buying the Yamaha PG 1 guitar and instrument preamplifier. We hope that you will get years of outstanding performance from this unit. Please read the instruction manual carefully before using.

The PG 1 is a rack-mountable guitar and instrument preamplifier that was developed especially to meet the needs of today's musicians. In addition to the independent A and B sound channels, the PG 1 incorporates a parametric equalizer. This can be used to compensate for the frequency response of the instrument or the acoustics of the room, or to modify the sound as you desire. A new-type footswitch that transmits 3 control signals with a single cable is provided, increasing the unit's flexibility in live performances. The PG 1 also has input jacks for 6 channels. Allowing it to be used in studios and permitting the connection of effect units and other auxiliary equipment.

TABLE OF CONTENTS

CAUTION	2
SPECIFICATIONS	2
FRONT PANEL	3
REAR PANEL	5
EXAMPLE SETUP	7
BLOCK DIAGRAM	8
FREQUENCY RESPONSE GRAPH	9
SERVICE	10

PRE-USE CAUTION

- We recommend that you read the entire operating manual. Be sure to keep it in a safe place.
 - Before turning ON the power switch or plugging in the AC power cord, be sure to turn the volume all the way down.
 - When connecting a guitar or an instrument, be sure to plug the connecting cord into the instrument first and then plug the other end into the PG 1. Plugging the instrument in last may harm your speakers.
 - Before connecting the PG 1 to a power amplifier or other auxiliary equipment, be sure to turn OFF power on the PG 1. Also, when applying power, turn ON the PG 1 first and other equipment LAST.
- **VOLTAGE SELECTOR (GENERAL MODEL ONLY)**
Before turning the unit ON, make sure that the rear-panel voltage selector is properly set according to the line voltage in your area.

SPECIFICATIONS

GAIN

36 dB (INPUT → OUTPUT/1 kHz, A ch)
63 dB (INPUT → OUTPUT/1 kHz, B ch)
54 dB (INPUT → SEND OUTPUT/1 kHz, A ch)
56 dB (INPUT → BAL. OUTPUT/1 kHz, A ch)
15 dB (RETURN INPUT → OUTPUT)

NOISE

Less than -75 dB (all controls at Min., A ch)
Less than -77 dB (all controls at Min., B ch)
Less than -67 dB (VOL., TREBLE, MID., BASS at Max., A ch)
Less than -49 dB (GAIN, M.VOL., TREBLE, MID., BASS at Max., B ch)

EQUALIZER

(P. EQ) LEVEL : ±15 dB
Q : 0.35 - 3.0
FREQUENCY : 100 Hz - 5 kHz
EQ LEVEL : ±15 dB

CONTROLS (FRONT PANEL)

A/B switch
A ch : VOLUME (PULL FAT), TREBLE (PULL BRIGHT), MIDDLE, BASS
B ch : GAIN (PULL FAT), MASTER VOL., TREBLE (PULL BRIGHT), MIDDLE, BASS
EQ : A-A/B-B select switch, LPF/P. EQ/HPF select switch, LEVEL, Q, FREQUENCY, EQ LEVEL
REVERB, PHONES LEVEL, POWER switch
POWER socket, RETURN LEVEL, SEND LEVEL, BAL. OUTPUT, OUTPUT LEVEL, GROUND (Lift) switch
GROUND Polarity switch : U.S. and Canadian models only
VOLTAGE SELECTOR : General model only

(REAR PANEL)

REVERB FOOT SWITCH

Accutronics spring type
A ch / B ch, EQ ON/OFF, REVERB ON/OFF

INPUTS

INPUT jack -20 dB/1 MΩ
RETURN INPUT jack -20 dB/25 kΩ

OUTPUTS

OUTPUT jack 0 dB/10 kΩ
OUTPUT jack (rear) 0 dB/10 kΩ
PHONES OUTPUT jack -1 dB/8 Ω
SEND OUTPUT jack 0 dB/10 kΩ
BALANCED OUTPUT 0 dB/600 Ω

POWER REQUIREMENTS

U. S. & Canadian models: 120V AC, 60Hz 15W
General model: 110/120, 220/240V AC, 50/60 Hz 20W

DIMENSION (W x H x D)

480 x 54 x 325 mm (18-7/8" x 2-1/8" x 12-3/4")

WEIGHT

5.7 kg (12.54 lbs)

ACCESSORIES

Foot switch

* 0dB is referenced to 0.775 V RMS and 6 dB/octave at 12.47 kHz filter weighted.

Specifications subject to change without notice.

FRONT PANEL CONTROLS

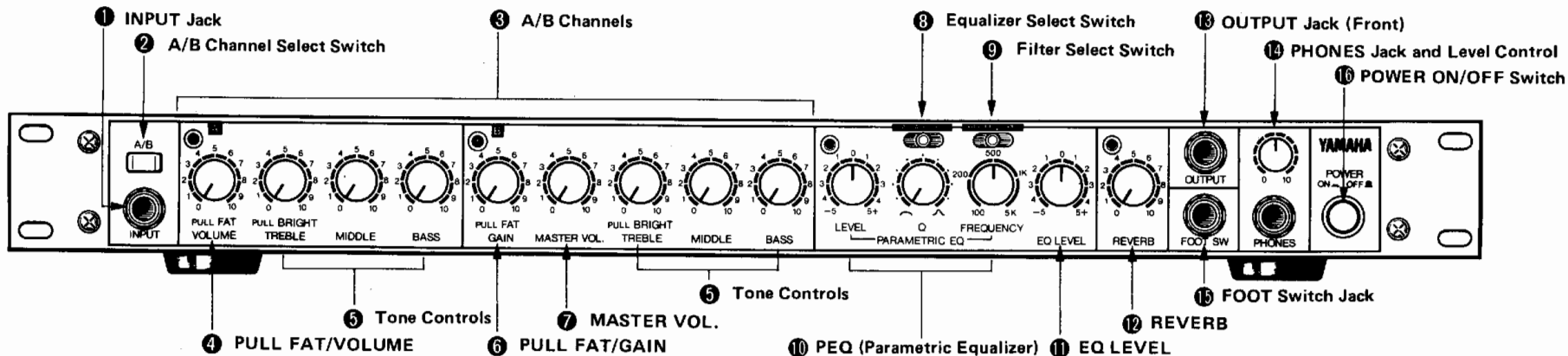

1 INPUT Jack

Plug in the instrument here.

2 A/B Channel Select Switch

Selects A or B.

- The indicator of the selected sound channel A or B lights.
- The special footswitch can be used to remotely switch between A and B. In this case, the switch cannot be used to make the A/B selection.

3 A/B Channels

A is the normal channel, while B has a GAIN control for generating distortion.

4 PULL FAT/VOLUME (A only)

Rotating the control adjusts the volume level. Pulling the control out emphasizes the middle frequencies, producing a "fat" sound.

5 TONE CONTROLS

PULL BRIGHT/TREBLE

Adjusts the high (treble) frequencies. Turning the control clockwise emphasizes the treble frequencies. Pulling the control out provides an additional high-frequency boost.

MIDDLE

Adjusts the middle frequencies. Turning the control clockwise emphasizes the middle frequencies.

BASS

Adjusts the low frequencies. Turning the control clockwise emphasizes the low frequencies.

6 PULL FAT/GAIN (B only)

This adjusts the gain of the sound channel B. Turning the control clockwise increases the gain, and at some point overdrive distortion will begin to

be produced. The exact effect varies with the output level of the guitar pickup. Pulling the control out emphasizes the middle frequencies.

7 MASTER VOL. (B only)

Use this to set overall volume after the GAIN control has been set. Volume can be matched to the sound channel A by playing while switching between A and B.

■ EQUALIZER Section

The equalizer section can be switched to LPF (low-pass filter), PEQ (parametric equalizer), or HPF (high-pass filter) operation.

8 Equalizer Select Switch

Selects which sound channel to equalize. Set to either A or B to equalize the output from the corresponding sound channel only. Set to A/B to equalize the output from both channels.

9 Filter Select Switch

Selects the equalizer mode. When the switch is set to LPF (low-pass filter) or HPF (high-pass filter), only the filter section of the equalizer operates, and the LEVEL control has no effect. When the switch is set to PEQ (parametric equalizer), the equalizer section operates as a parametric equalizer.

10 PEQ (Parametric Equalizer)

■ LEVEL

Sets the boost or cut to be applied to the frequency range around the center frequency specified by the FREQUENCY control, over a ± 15 dB range. When the control is in the center (0 click-stop) position the response is flat. when rotated toward "+" the response is boosted (\wedge) and when rotated toward "-" the response is cut (\vee).

■ Q

Sets the frequency range to be equalized to wide (\wedge) or narrow (\wedge). Turning the control to the right narrows the frequency range until only the center frequency is boosted or cut.

■ FREQUENCY

When the filter select switch is set to PEQ, this control adjusts the center frequency of the range to be equalized. When the switch is set to LPF or HPF, the control adjusts the filter cutoff frequency.

11 EQ LEVEL

Controls the overall level of the equalizer block. Since the various settings of the equalizer affect the output level, this control can be used to compensate.

Then the output level will be the same with and without the equalizer.

- Plugging the optional footswitch into the FOOT Switch jack allows the equalizer to be turned on and off remotely.

12 REVERB

Adjusts the amount of spring echo effect. When the control is set at 0 there is no effect; when it is set at 10 there is a strong effect. The reverb effect can be turned on and off via the remote foot switch.

13 OUTPUT Jack (Front)

This is connected in parallel with the rear panel output jack. A power amp or a speaker system with a built-in amp should be connected.

14 PHONES Jack and Level Control

Headphones may be plugged in here. Use low-impedance headphones. Use the headphone level

control to set the most comfortable headphone listening level.

15 FOOT SW Jack

The optional footswitch may be connected here. The footswitch may be used to select sound channel A or B, to turn the equalizer on and off, and to turn the reverb on and off.

- The footswitch is a special type that allows three control functions to be transmitted with a single, standard shielded cable with conventional $\frac{1}{4}$ " phone plugs. Any cable of convenient length can be used.
- Indicators on the footswitch and the PG 1 show the status of the footswitch.
- Connecting the footswitch prevents the PG 1 sound channel A/B selector switch from operating.

16 POWER ON/OFF Switch

Pressing this switch turns AC power to the unit ON or OFF.

● LEVEL CONTROL

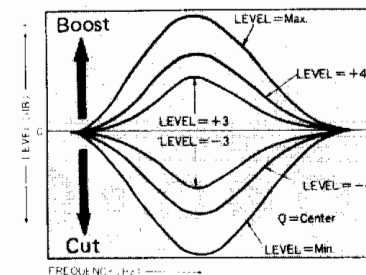

● Q CONTROL

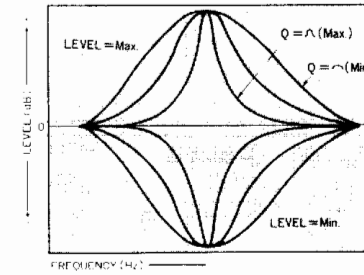

● FREQUENCY CONTROL

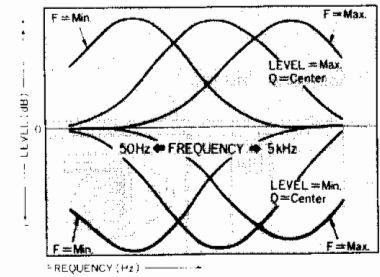

REAR PANEL CONTROLS AND CONNECTIONS

U.S. & Canadian Models

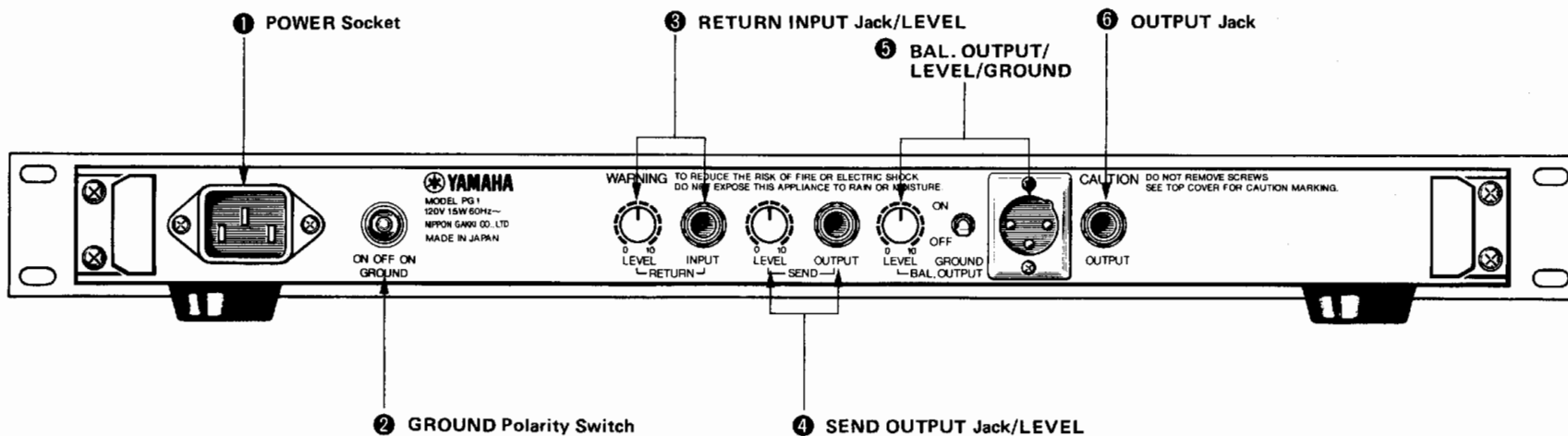

General Model

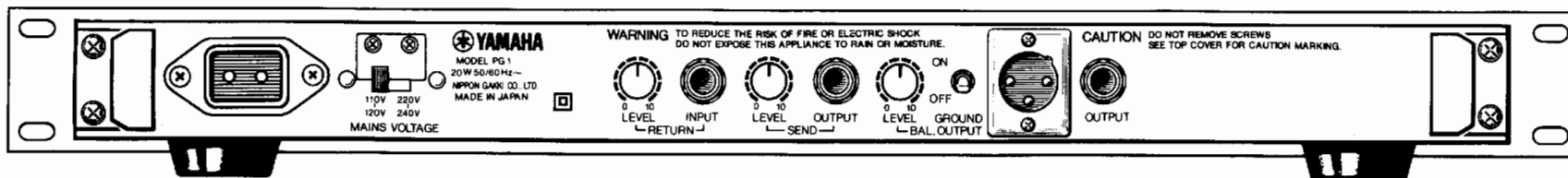

❶ POWER Socket

Plug the supplied AC power cord in here.

❷ GROUND Polarity Switch

(U.S. & Canadian models only)

Normally set to OFF. If hum or noise is a problem, try setting the switch to the right or left ON position to reduce the problem.

❸ RETURN INPUT Jack/LEVEL**❹ SEND OUTPUT Jack/LEVEL**

When using an effects unit, connect it between the SEND and RETURN jacks. Adjust the input and output levels to match the unit.

❺ BAL. OUTPUT/LEVEL/GROUND

This connector provides low-impedance 600 Ω line-level balanced output. The matching connector is an XLR female type, perfect for connection to professional sound reinforcement and recording equipment. If a ground loop between the PG 1 and the connected equipment causes hum, try setting the GOUND (Lift) switch to OFF.

❻ OUTPUT Jack

This is connected in parallel with the front panel output jack. Connect a power amp or a speaker system with a built-in amp.

VOLTAGE SELECTOR (GENERAL MODEL ONLY)

If your PG 1 has a voltage selector, check that it is set to your local voltage before you plug it in. If not properly set, unscrew the two switch-guard retaining screws, and reset the switch to indicate your supply voltage (110 to 120V or 220 to 240V). After setting the voltage selector switch to the correct voltage, replace the switch guard and attach it with two retaining screws.

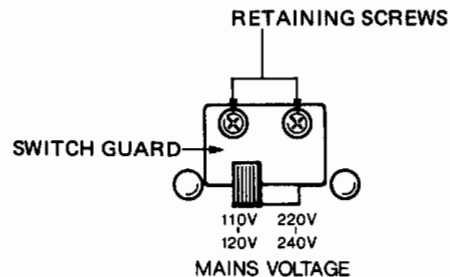

EXAMPLE SETUP

Send and Return connections

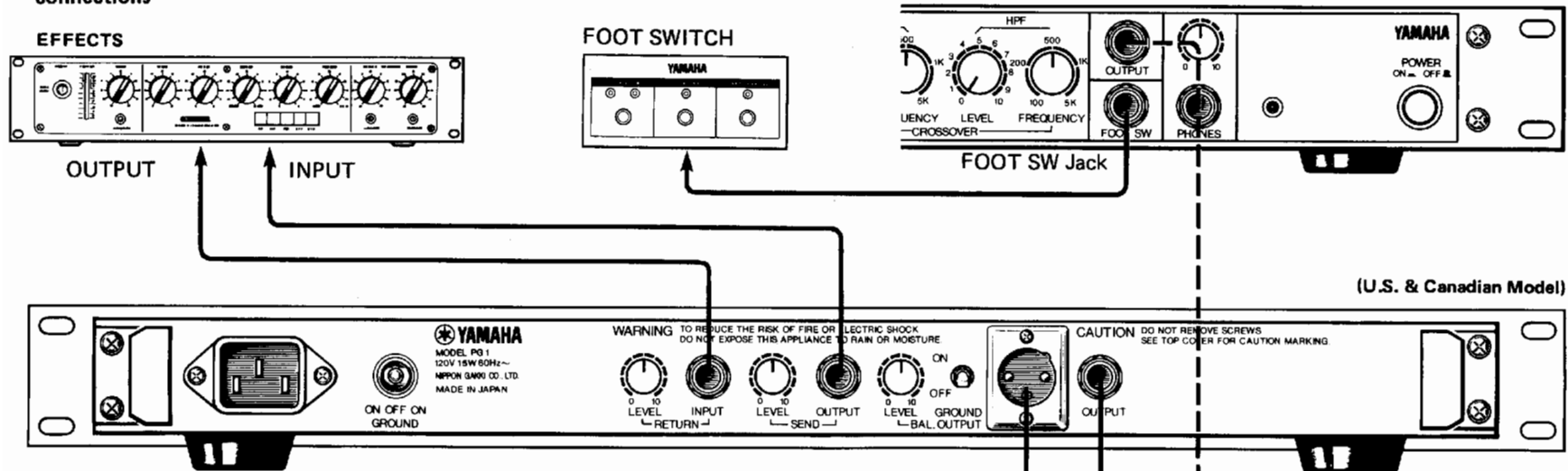

Balanced output connections

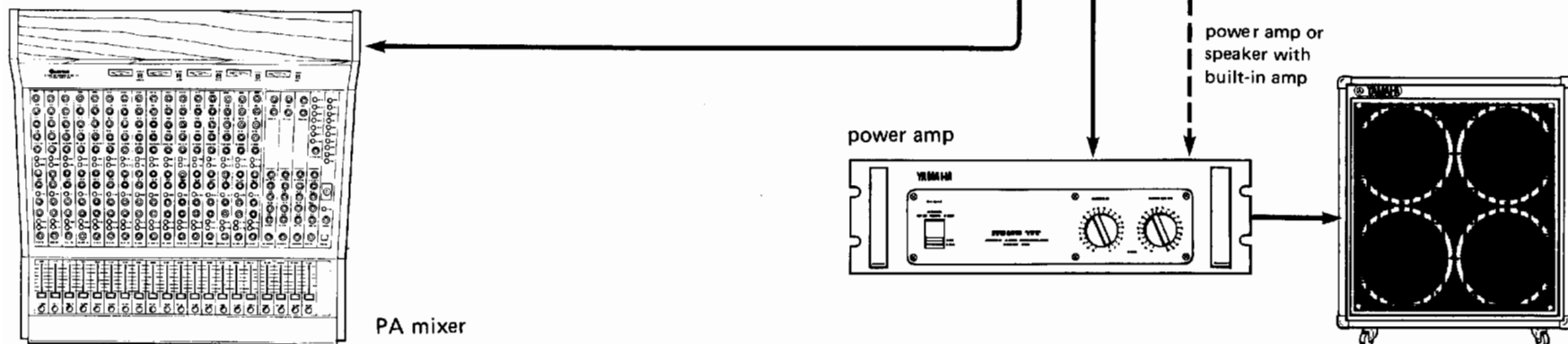

BLOCK DIAGRAM

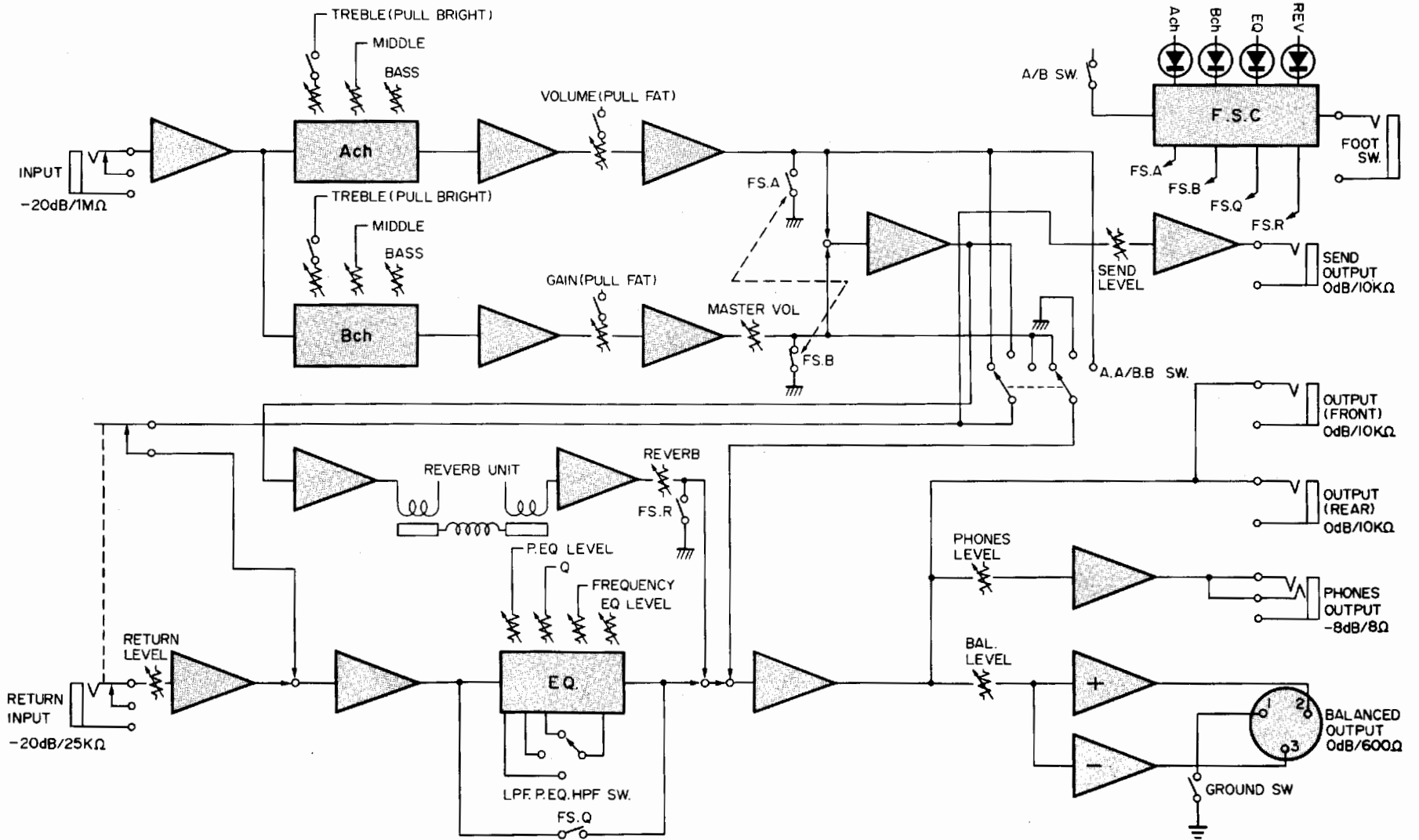

FREQUENCY RESPONSE GRAPHS

INPUT → OUTPUT (A ch)

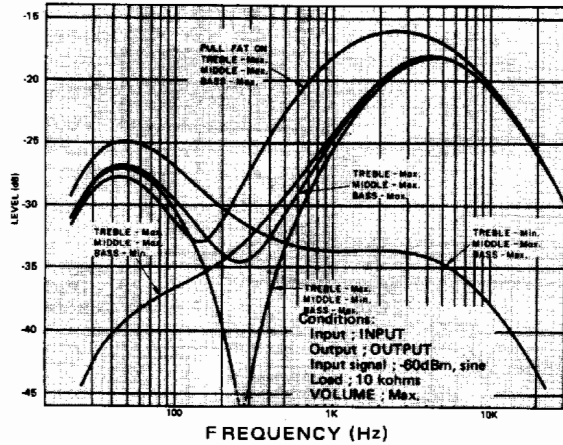

PULL BRIGHT (A ch)

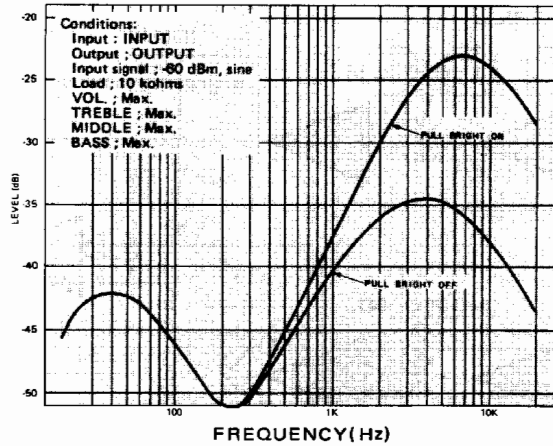

RETURN INPUT → BALANCED OUTPUT

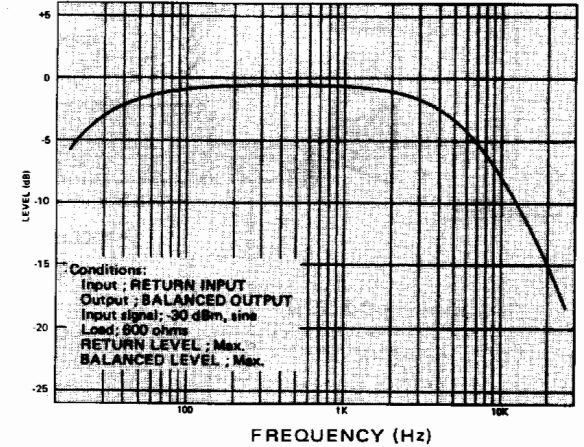

PARAMETRIC EQUALIZER

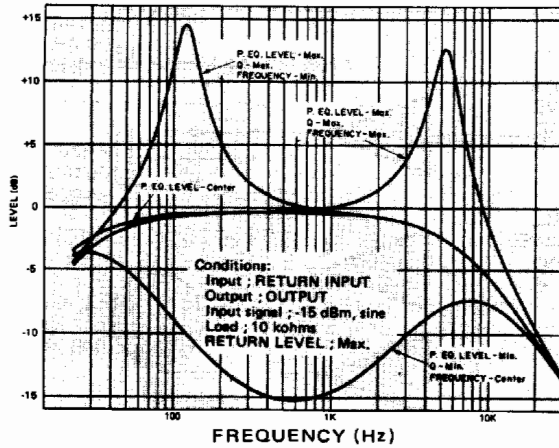

LOW PASS FILTER

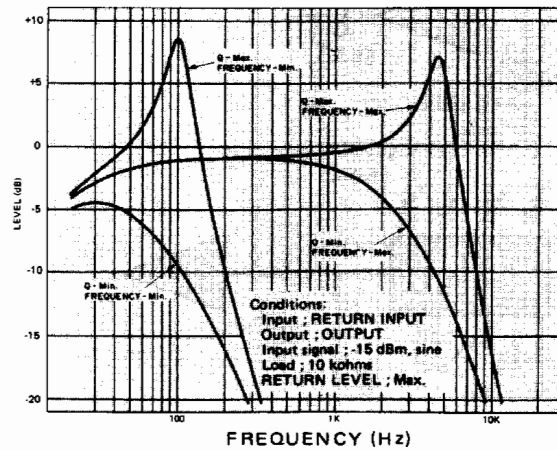

HIGH PASS FILTER

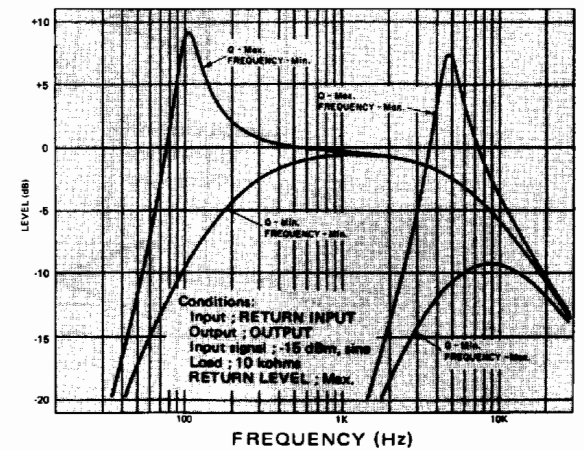

* Input signal; 0dB is referenced to 0.775VRMS.

WARNING: TO REDUCE THE RISK OF FIRE OR ELECTRIC SHOCK, DO NOT EXPOSE THIS APPLIANCE TO RAIN OR MOISTURE. THERE ARE NO USER-SERVICEABLE PARTS INSIDE. REFER SERVICING TO A QUALIFIED SERVICE PERSONNEL.

SERVICE

The PG 1 is supported by Yamaha's worldwide network of qualified dealer service personnel. In the event of a problem, contact your nearest Yamaha dealer or authorized service center.

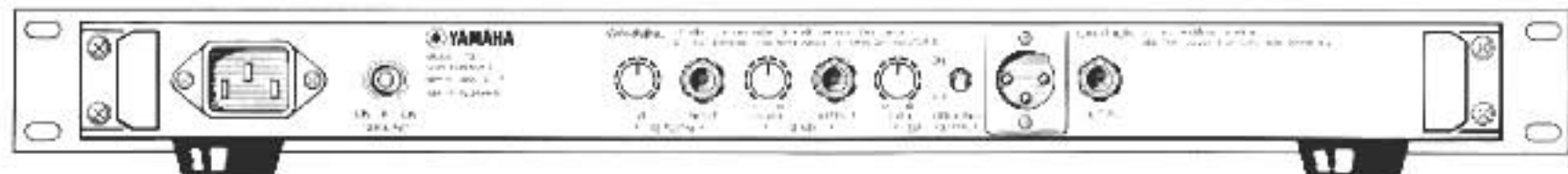

YAMAHA